

▲ DALI Sürücü ve Aydınlatma Bağlantı Diyagramı

DMX AĞ GEÇİDİ MODÜLÜ

TIS – DMX 48 KANALLI MODÜL

Model: TIS-DMX-48

TIS

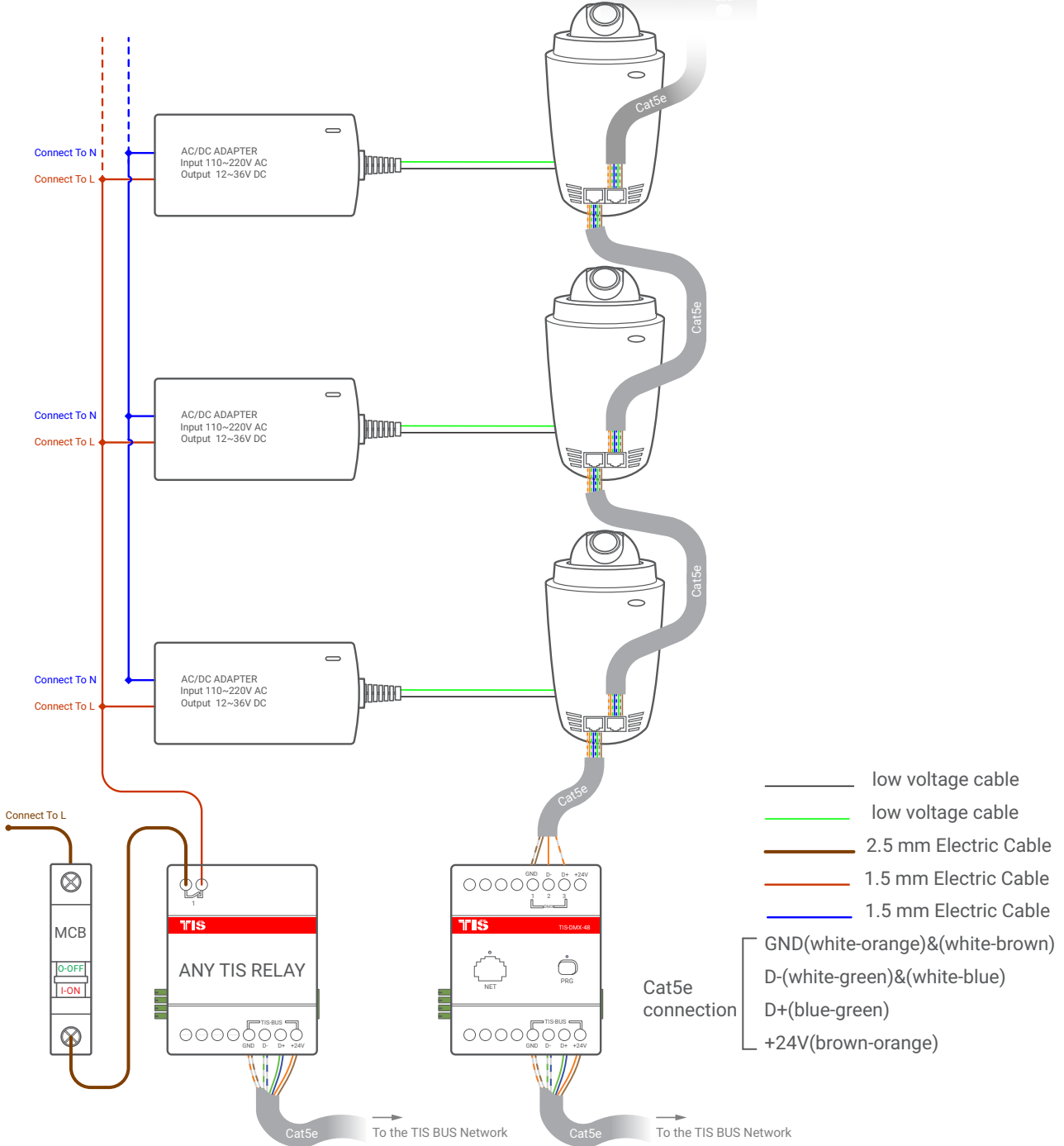

▲ Figure 1: DMX Lights Connection Diagram

TIS

Copyright © 2020 TIS, All Rights Reserved
TIS Logo is a Registered Trademark of Texas Intelligent System LLC in the United States of America. This company takes TIS Control Ltd. in other countries. All of the Specifications are subject to change without notice.

TEXAS INTELLIGENT SYSTEM LLC
SUITE# 610, 860 NORTH DOROTHY DR
RICHARDSON
TX 75081.USA

TIS CONTROL TÜRKİYE
DEMİRCİKARA MAH. B. ONAT CAD.
1419.SK OCEAN CITY SİTESİ B BLOK
KAT:2 D:3 MURATPASA/ANTALYA

DMX AĞ GEÇİDİ MODÜLÜ

TIS – DMX 48 KANALLI MODÜL

Model: TIS-DMX-48

TIS

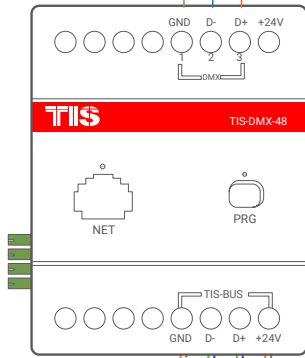
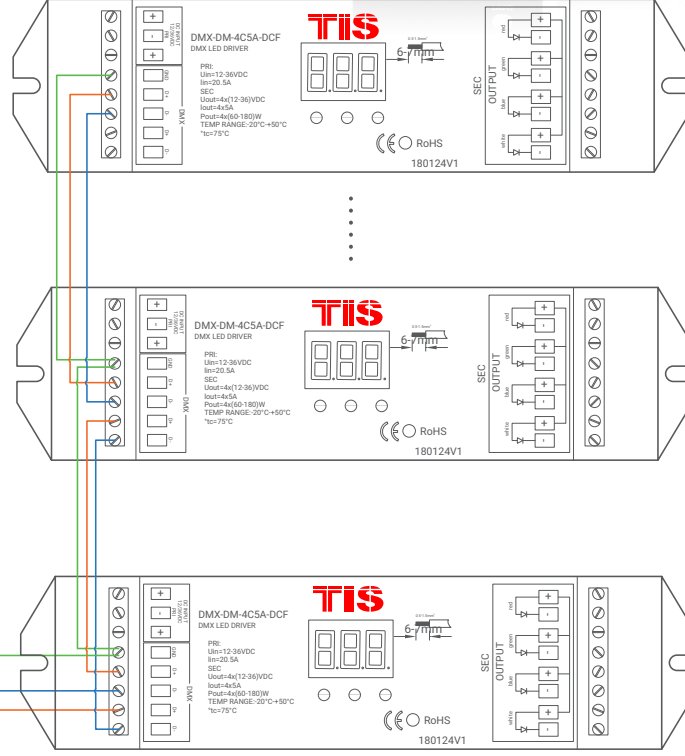

- low voltage cable
- low voltage cable
- low voltage cable

Cat5e connection — GND(white-orange)&(white-brown)
D-(white-green)&(white-blue)
D+(blue-green)
+24V(brown-orange)

Cat5e To the TIS BUS Network

▲ DMX ve DMX Sürücüsü Bağlantı Diyagramı

TIS

Copyright © 2020 TIS, All Rights Reserved
TIS Logo is a Registered Trademark of Texas Intelligent System LLC in the United States of America. This company takes TIS Control Ltd. in other countries. All of the Specifications are subject to change without notice.

TEXAS INTELLIGENT SYSTEM LLC
SUITE# 610. 860 NORTH DOROTHY DR
RICHARDSON
TX 75081.USA

TIS CONTROL TÜRKİYE
DEMİRCİKARA MAH. B. ONAT CAD.
1419.SK OCEAN CITY SİTESİ B BLOK
KAT:2 D:3 MURATPAŞA/ANTALYA

DMX AĞ GEÇİDİ MODÜLÜ

TIS – DMX 48 KANALLI MODÜL

Model: TIS-DMX-48

TIS

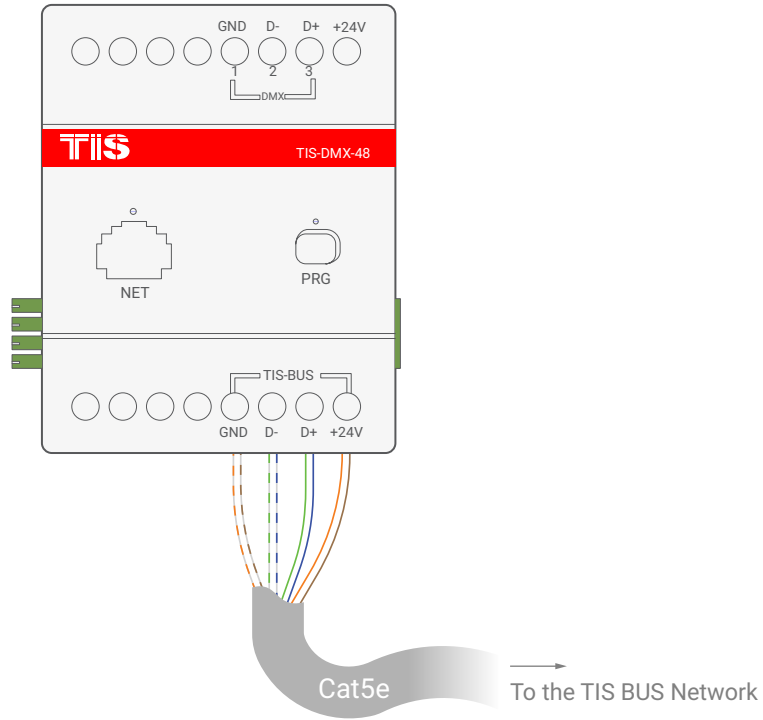

Cat5e connection

- GND(white-orange)&(white-brown)
- D-(white-green)&(white-blue)
- D+(blue-green)
- +24V(brown-orange)

▲ Modül Bus Bağlantı Renk Kodları

TIS

Copyright © 2020 TIS, All Rights Reserved

TIS Logo is a Registered Trademark of Texas Intelligent System LLC in the United States of America. This company takes TIS Control Ltd. in other countries. All of the Specifications are subject to change without notice.

TEXAS INTELLIGENT SYSTEM LLC

SUITE# 610, 860 NORTH DOROTHY DR
RICHARDSON
TX 75081.USA

TIS CONTROL TÜRKİYE

DEMİRCİKARA MAH. B. ONAT CAD.
1419.SK OCEAN CITY SİTESİ B BLOK
KAT:2 D:3 MURATPAŞA/ANTALYA

DMX AĞ GEÇİDİ MODÜLÜ

TIS – DMX 48 KANALLI MODÜL

Model: TIS-DMX-48

TIS

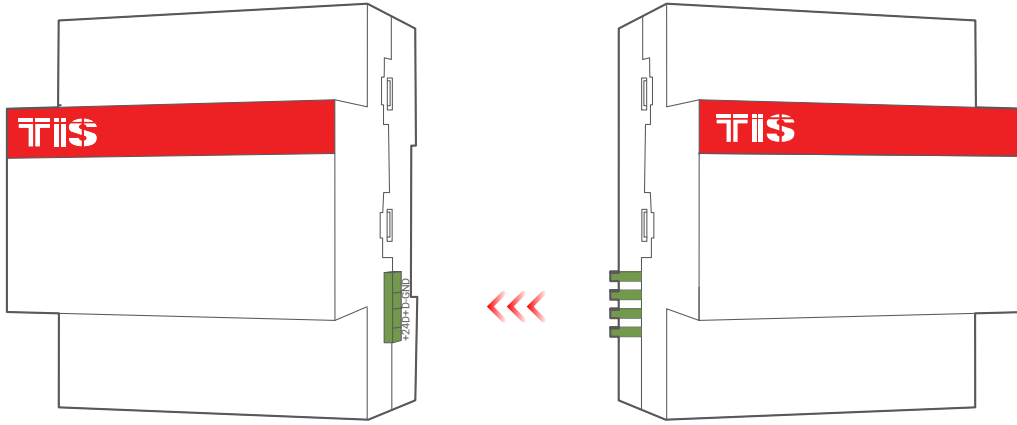

▲ DIN-Ray Bus Modül Bağlantı Şekli

TIS

Copyright © 2020 TIS, All Rights Reserved

TIS Logo is a Registered Trademark of Texas Intelligent System LLC in the United States of America. This company takes TIS Control Ltd. in other countries. All of the Specifications are subject to change without notice.

TEXAS INTELLIGENT SYSTEM LLC

SUITE# 610, 860 NORTH DOROTHY DR
RICHARDSON
TX 75081.USA

TIS CONTROL TÜRKİYE

DEMİRCİKARA MAH. B. ONAT CAD.
1419.SK OCEAN CITY SİTESİ B BLOK
KAT:2 D:3 MURATPAŞA/ANTALYA

DMX AĞ GEÇİDİ MODÜLÜ

TIS – DMX 48 KANALLI MODÜL

Model: TIS-DMX-48

TIS

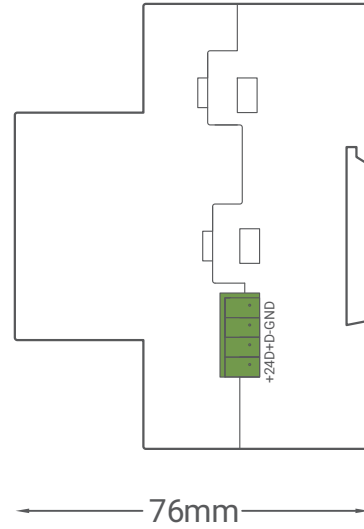
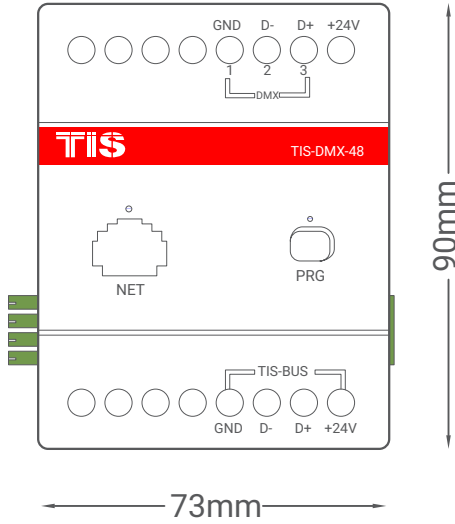

▲ TIS-DMX-48 Modül Boyutları

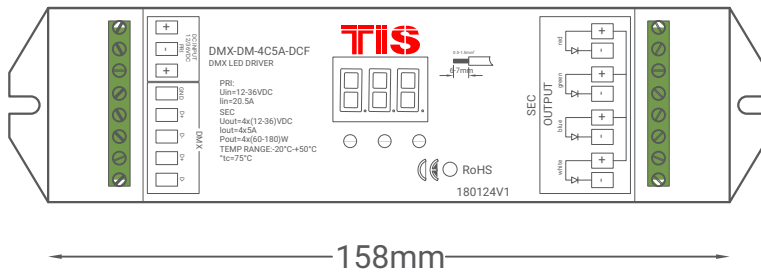

▲ DMX Sürücünün Boyutları

TIS

Copyright © 2020 TIS, All Rights Reserved
TIS Logo is a Registered Trademark of Texas Intelligent System LLC in the United States of America. This company takes TIS Control Ltd. in other countries. All of the Specifications are subject to change without notice.

TEXAS INTELLIGENT SYSTEM LLC
SUITE# 610, 860 NORTH DOROTHY DR
RICHARDSON
TX 75081.USA

TIS CONTROL TÜRKİYE
DEMİRCİKARA MAH. B. ONAT CAD.
1419.SK OCEAN CITY SİTESİ B BLOK
KAT:2 D:3 MURATPAŞA/ANTALYA