

▲ TER-AUD-A ve ADD-3R-5A Aydınlatma Bağlantı Diyagramı

TIS TERRE PANEL

Terre Audio Dokunmatik Tuş Takımı

Model: TER-AUD-A

TIS

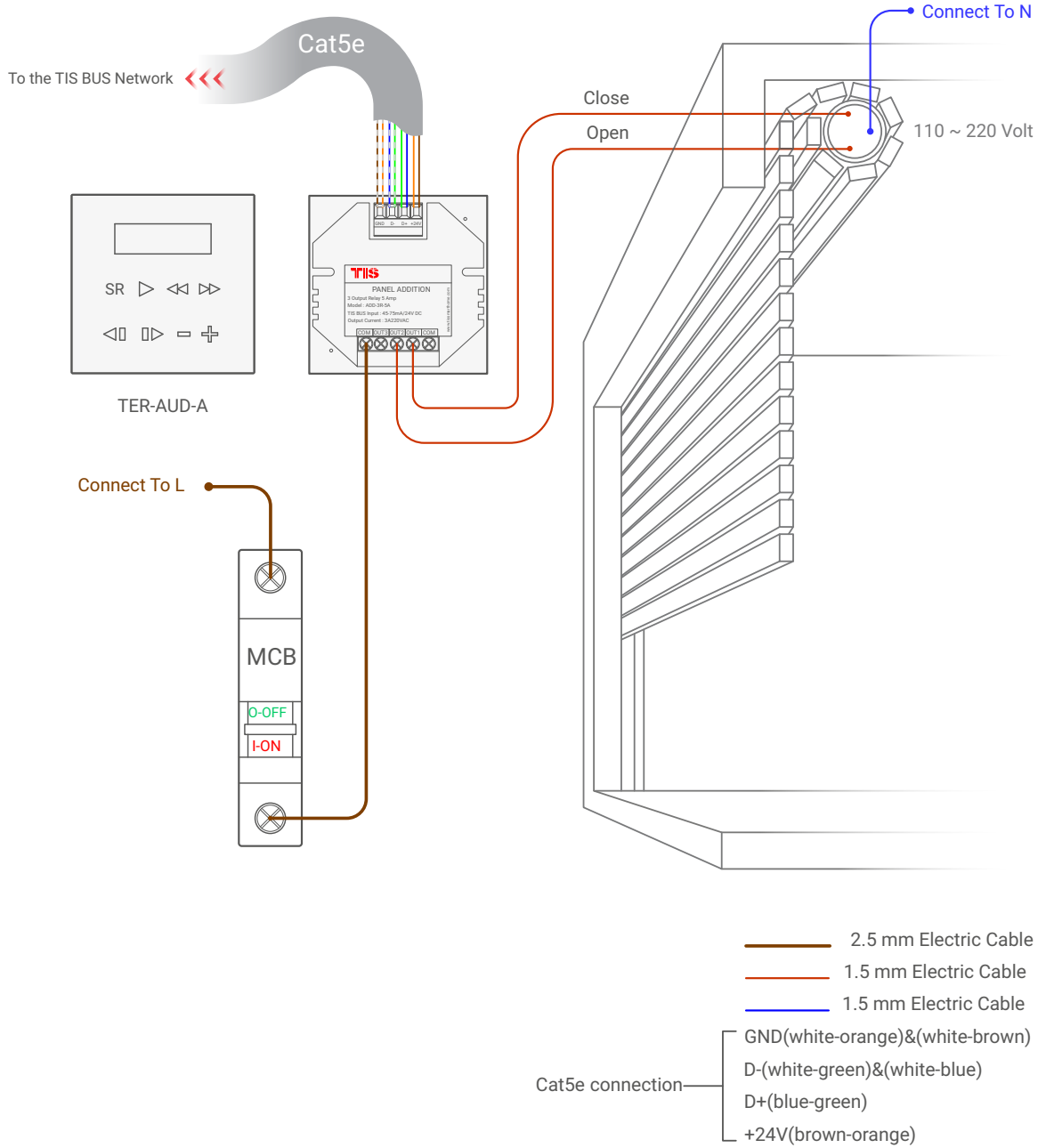

▲ TER-AUD-A ve ADD-3R-5A Motor Bağlantı Diyagramı

TIS

Copyright © 2020 TIS, All Rights Reserved

TIS Logo is a Registered Trademark of Texas Intelligent System LLC in the United States of America. This company takes TIS Control Ltd. in other countries. All of the Specifications are subject to change without notice.

TEXAS INTELLIGENT SYSTEM LLC

SUITE# 610, 860 NORTH DOROTHY DR
RICHARDSON
TX 75081,USA

TIS CONTROL TÜRKİYE

DEMİRCİKARA MAH. B. ONAT CAD.
1419.SK OCEAN CITY SİTESİ B BLOK
KAT:2 D:3 MURATPAŞA/ANTALYA

TIS TERRE PANEL

Terre Audio Dokunmatik Tuş Takımı

Model: TER-AUD-A

TIS

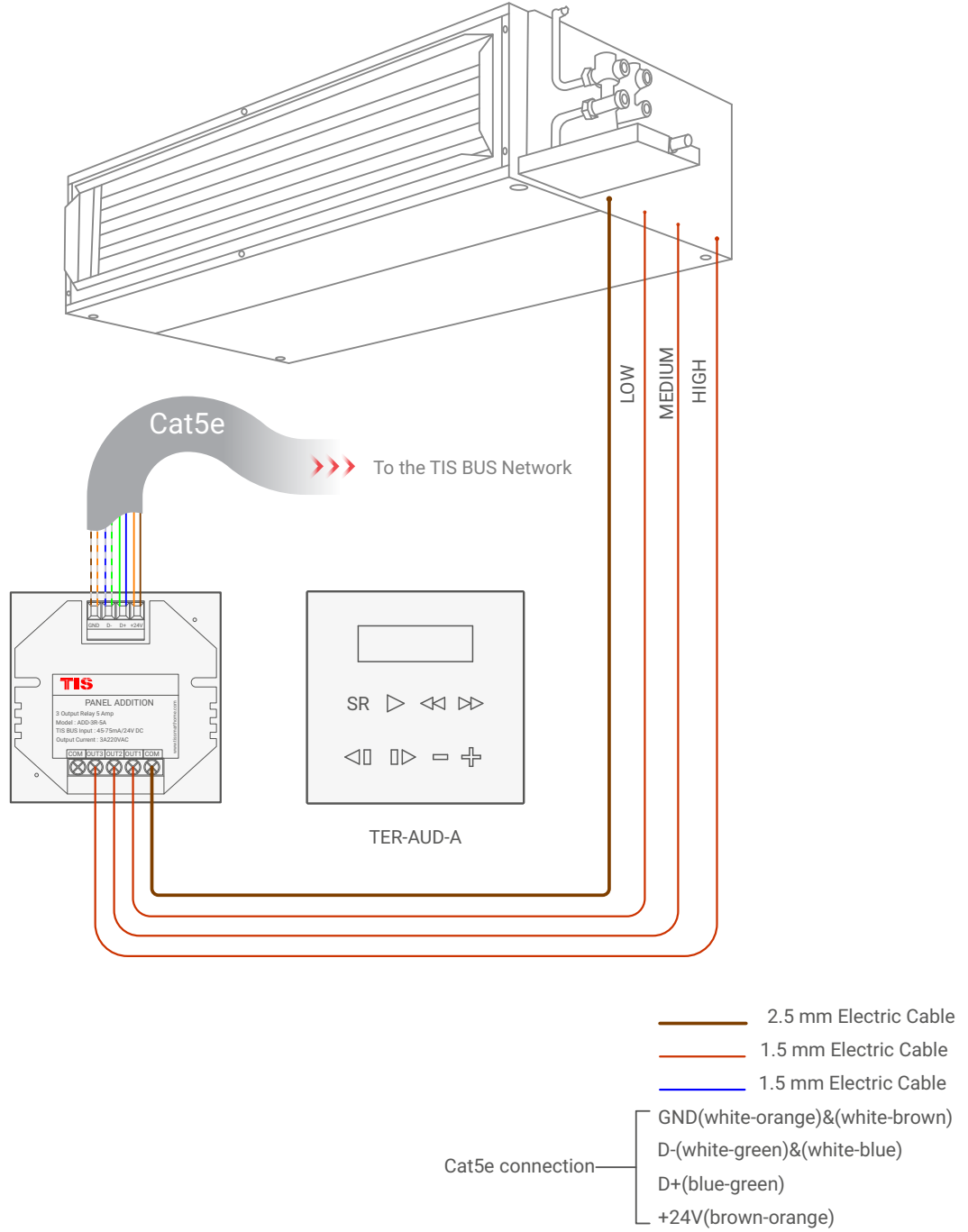
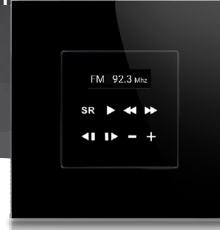

▲ TER-AUD-A & ADD-3R-5A FCU Bağlantı Diyagramı

TIS

Copyright © 2020 TIS, All Rights Reserved

TIS Logo is a Registered Trademark of Texas Intelligent System LLC in the United States of America. This company takes TIS Control Ltd. in other countries. All of the Specifications are subject to change without notice.

TEXAS INTELLIGENT SYSTEM LLC

SUITE# 610, 860 NORTH DOROTHY DR
RICHARDSON
TX 75081.USA

TIS CONTROL TÜRKİYE

DEMİRCİKARA MAH. B. ONAT CAD.
1419.SK OCEAN CITY SİTESİ B BLOK
KAT:2 D:3 MURATPAŞA/ANTALYA

TIS TERRE PANEL

Terre Audio Dokunmatik Tuş Takımı

Model: TER-AUD-A

TIS

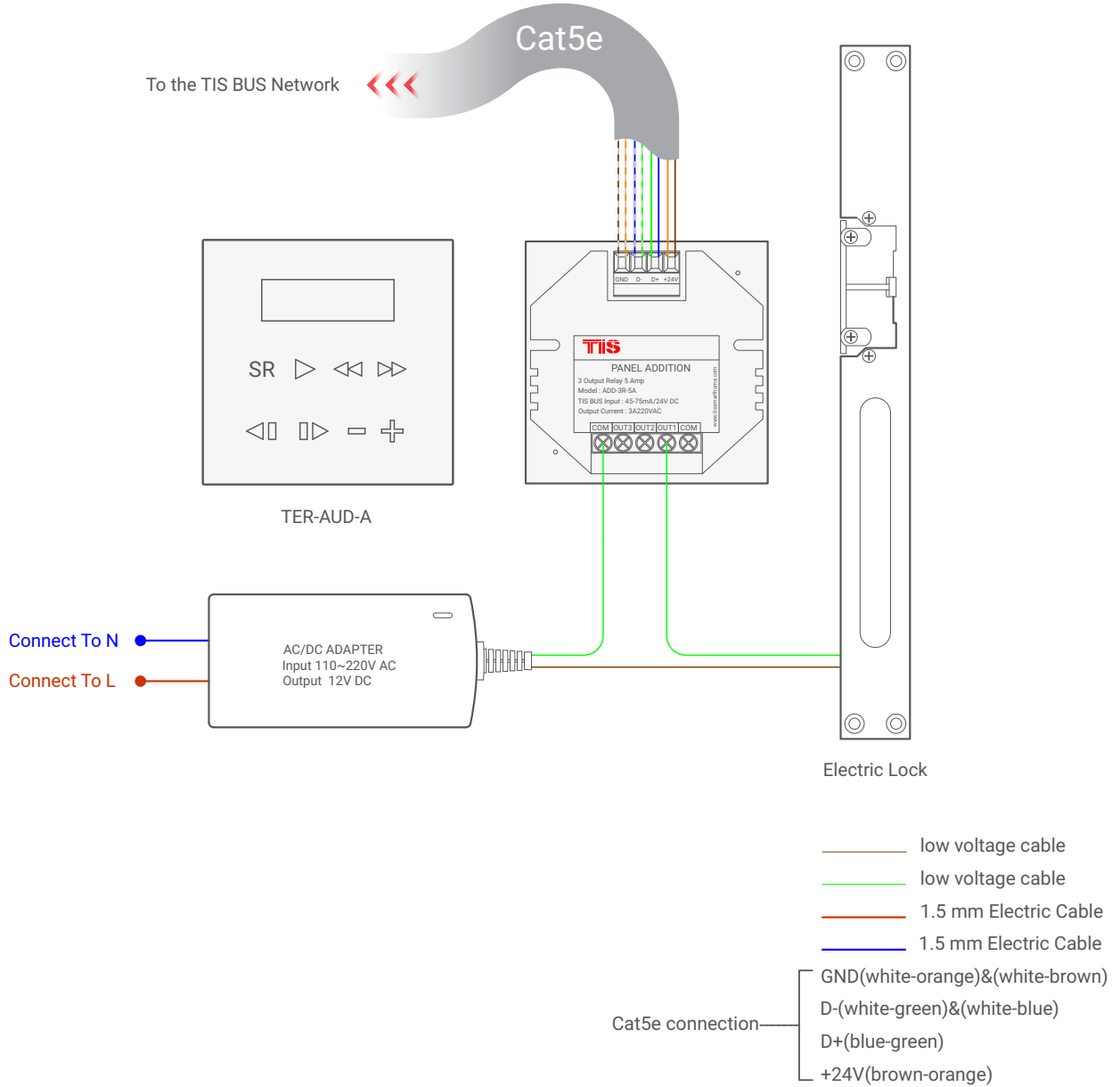

▲ TER-AUD-A ve ADD-3R-5A Elektrik Kilidi Bağlantı Diyagramı

TIS

Copyright © 2020 TIS, All Rights Reserved
TIS Logo is a Registered Trademark of Texas Intelligent System LLC in the United States of America. This company takes TIS Control Ltd. in other countries. All of the Specifications are subject to change without notice.

TEXAS INTELLIGENT SYSTEM LLC
SUITE# 610, 860 NORTH DOROTHY DR
RICHARDSON
TX 75081.USA

TIS CONTROL TÜRKİYE
DEMİRCİKARA MAH. B. ONAT CAD.
1419.SK OCEAN CITY SİTESİ B BLOK
KAT:2 D:3 MURATPAŞA/ANTALYA

TIS TERRE PANEL

Terre Audio Dokunmatik Tuş Takımı

Model: TER-AUD-A

TIS

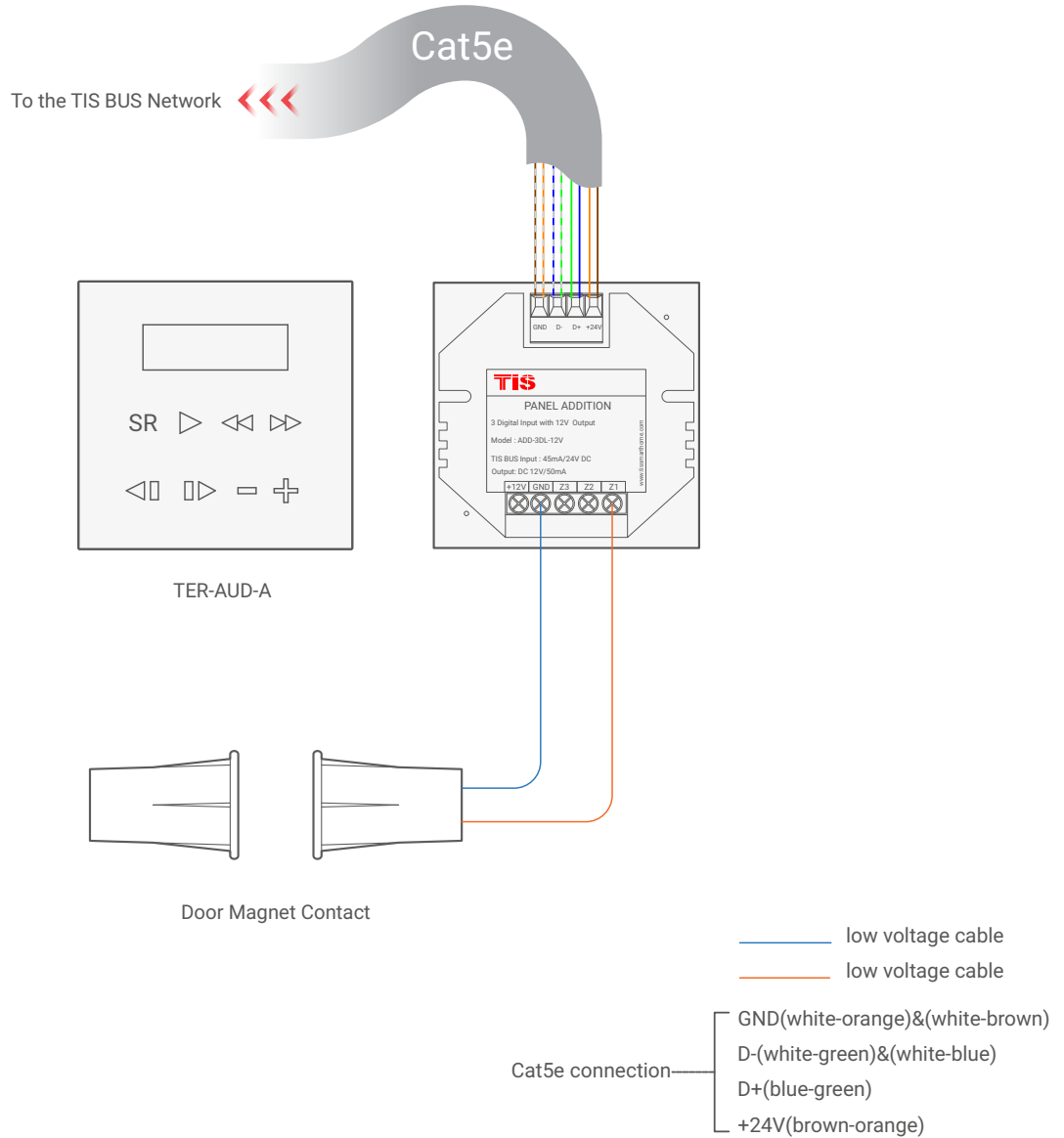

▲ TER-AUD-A ve ADD-3DL-12V Manyetik Kontak Kapı Bağlantı Diyagramı

TIS

Copyright © 2020 TIS, All Rights Reserved

TIS Logo is a Registered Trademark of Texas Intelligent System LLC in the United States of America. This company takes TIS Control Ltd. in other countries. All of the Specifications are subject to change without notice.

TEXAS INTELLIGENT SYSTEM LLC

SUITE# 610, 860 NORTH DOROTHY DR
RICHARDSON
TX 75081,USA

TIS CONTROL TÜRKİYE

DEMİRCİKARA MAH. B. ONAT CAD.
1419.SK OCEAN CITY SİTESİ B BLOK
KAT:2 D:3 MURATPAŞA/ANTALYA

TIS TERRE PANEL

Terre Audio Dokunmatik Tuş Takımı

Model: TER-AUD-A

TIS

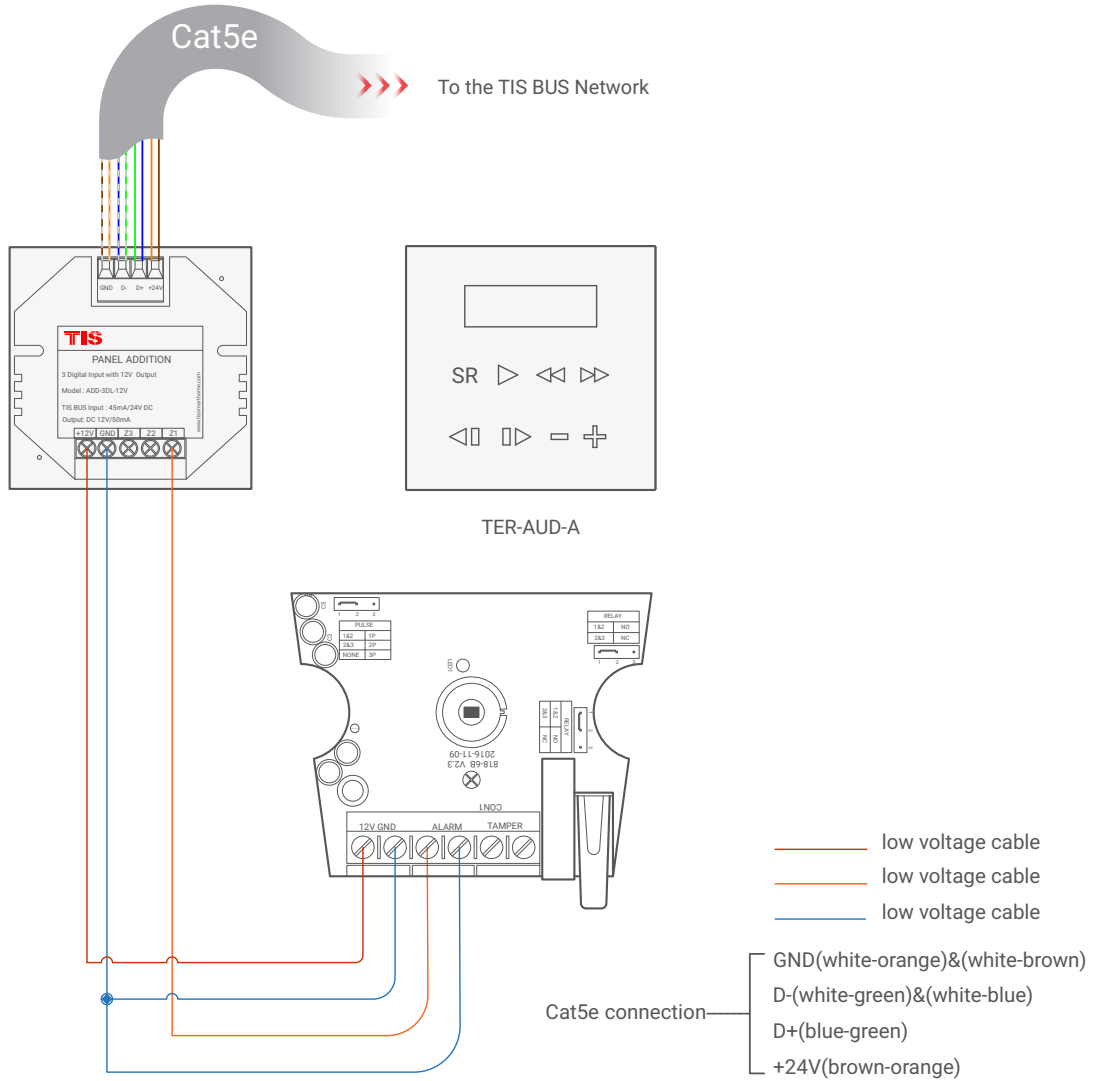

▲ TER-AUD-A ve ADD-3DL-12V Harici Sensör Bağlantı Diyagramı

TIS

Copyright © 2020 TIS, All Rights Reserved

TIS Logo is a Registered Trademark of Texas Intelligent System LLC in the United States of America. This company takes TIS Control Ltd. in other countries. All of the Specifications are subject to change without notice.

TEXAS INTELLIGENT SYSTEM LLC

SUITE# 610, 860 NORTH DOROTHY DR
RICHARDSON
TX 75081,USA

TIS CONTROL TÜRKİYE

DEMİRCİKARA MAH. B. ONAT CAD.
1419.SK OCEAN CITY SİTESİ B BLOK
KAT:2 D:3 MURATPAŞA/ANTALYA

TIS TERRE PANEL

Terre Audio Dokunmatik Tuş Takımı

Model: TER-AUD-A

TIS

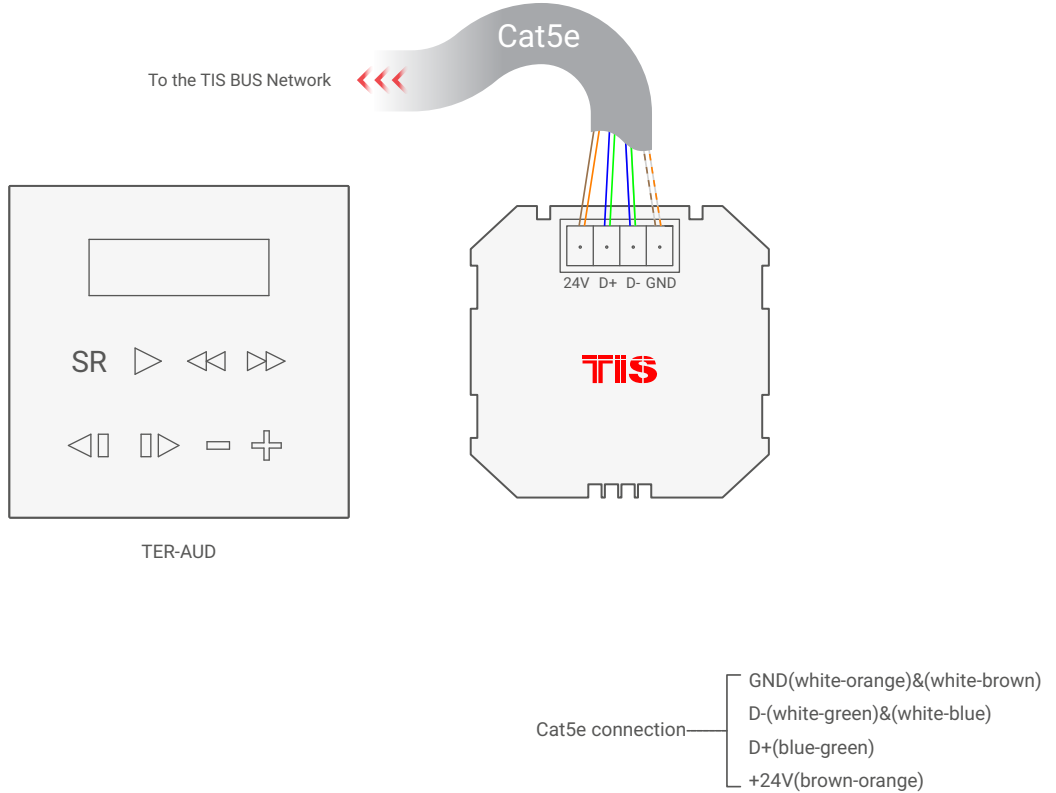

▲ TER-AUD Bus Bağlantı Diyagramı

TIS

Copyright © 2020 TIS, All Rights Reserved

TIS Logo is a Registered Trademark of Texas Intelligent System LLC in the United States of America. This company takes TIS Control Ltd. in other countries. All of the Specifications are subject to change without notice.

TEXAS INTELLIGENT SYSTEM LLC

SUITE# 610, 860 NORTH DOROTHY DR
RICHARDSON
TX 75081,USA

TIS CONTROL TÜRKİYE

DEMIRCIKARA MAH. B. ONAT CAD.
1419.SK OCEAN CITY SITESİ B BLOK
KAT:2 D:3 MURATPASA/ANTALYA

TIS TERRE PANEL

Terre Audio Dokunmatik Tuş Takımı

Model: TER-AUD-A

TIS

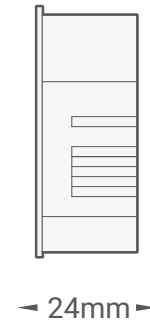
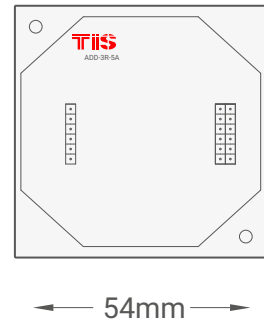
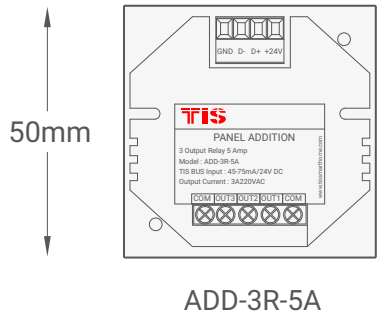
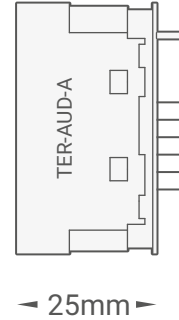
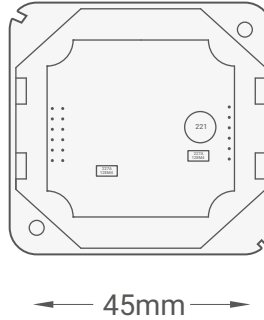
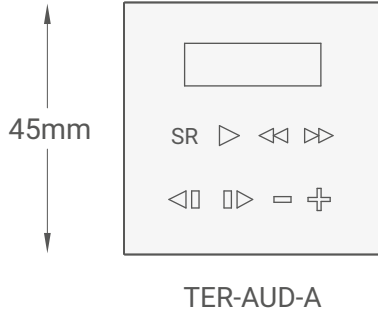
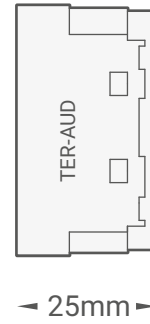
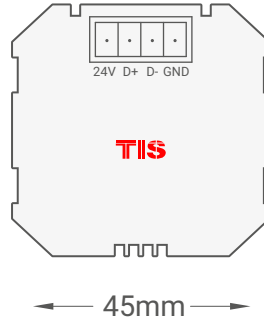
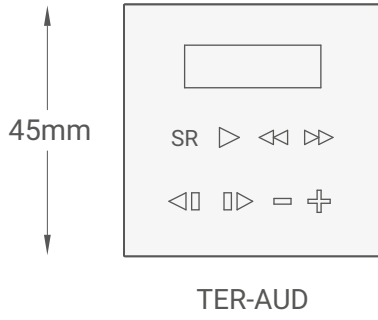
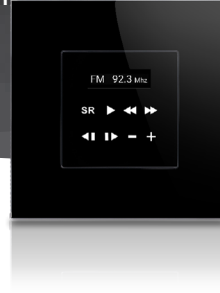

▲ Modül Boyutları

TIS

Copyright © 2020 TIS, All Rights Reserved
TIS Logo is a Registered Trademark of Texas Intelligent System LLC in the United States of America. This company takes TIS Control Ltd. in other countries. All of the Specifications are subject to change without notice.

TEXAS INTELLIGENT SYSTEM LLC
SUITE# 610, 860 NORTH DOROTHY DR
RICHARDSON
TX 75081,USA

TIS CONTROL TÜRKİYE
DEMİRCİKARA MAH. B. ONAT CAD.
1419.SK OCEAN CITY SİTESİ B BLOK
KAT:2 D:3 MURATPAŞA/ANTALYA