

▲ Aydınlatma Bağlantı Diyagramı

# ODA KONTROL ÜNİTESİ-RCU

8 GİRİŞ 8 ÇIKIŞ

Model: RCU-8OUT-8IN

TIS

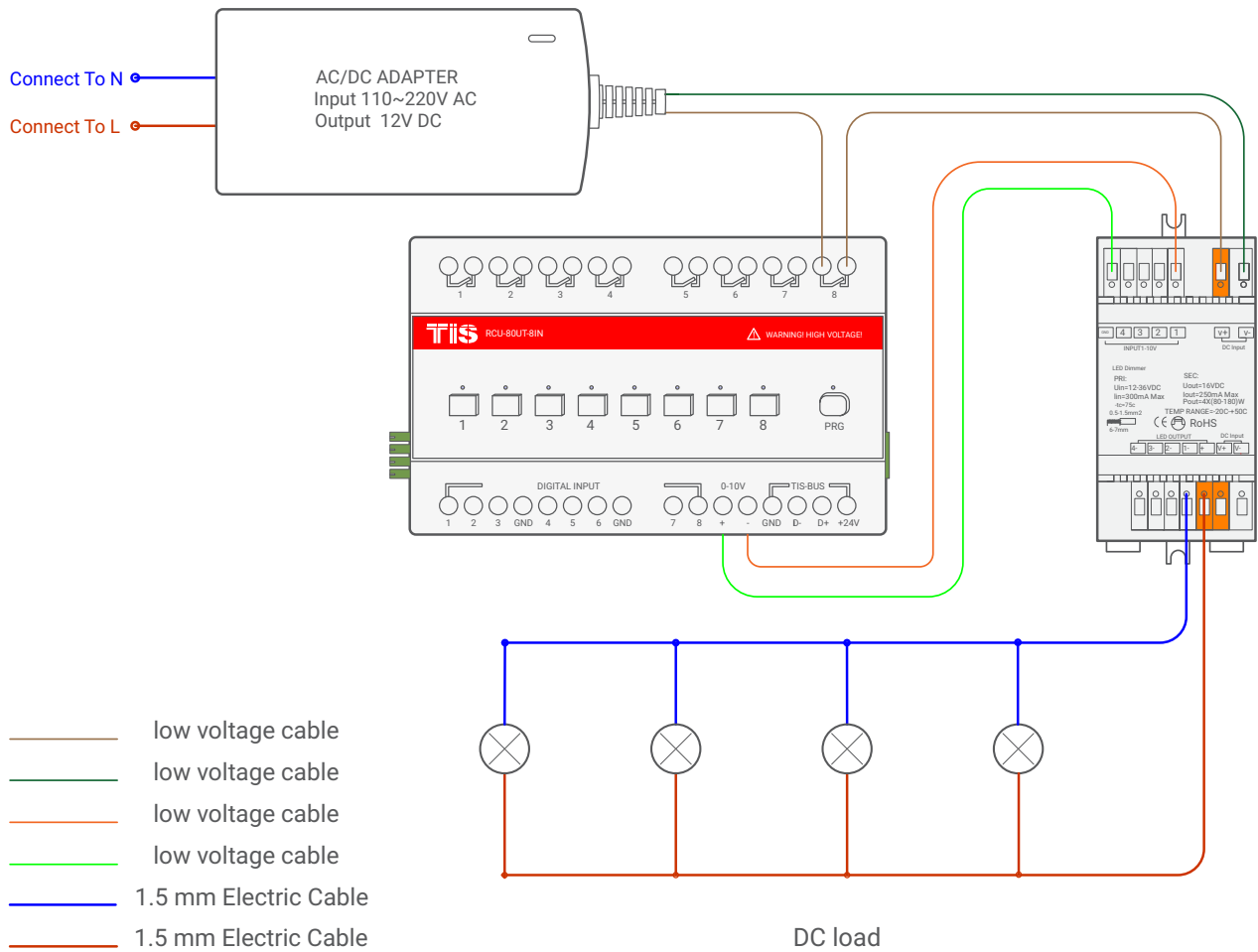

## ▲ Led Sürücü Bağlantı Diyagramı

TIS

Copyright © 2020 TIS, All Rights Reserved  
TIS Logo is a Registered Trademark of Texas Intelligent System LLC in the United States of America. This company takes TIS Control Ltd. in other countries. All of the Specifications are subject to change without notice.

TEXAS INTELLIGENT SYSTEM LLC  
SUITE# 610. 860 NORTH DOROTHY DR  
RICHARDSON  
TX 75081.USA

TIS CONTROL TÜRKİYE  
DEMİRCİKARA MAH. B. ONAT CAD.  
1419.SK OCEAN CITY SİTESİ B BLOK  
KAT:2 D:3 MURATPAŞA/ANTALYA

# ODA KONTROL ÜNİTESİ-RCU

8 GİRİŞ 8 ÇIKIŞ

Model: RCU-8OUT-8IN

TIS

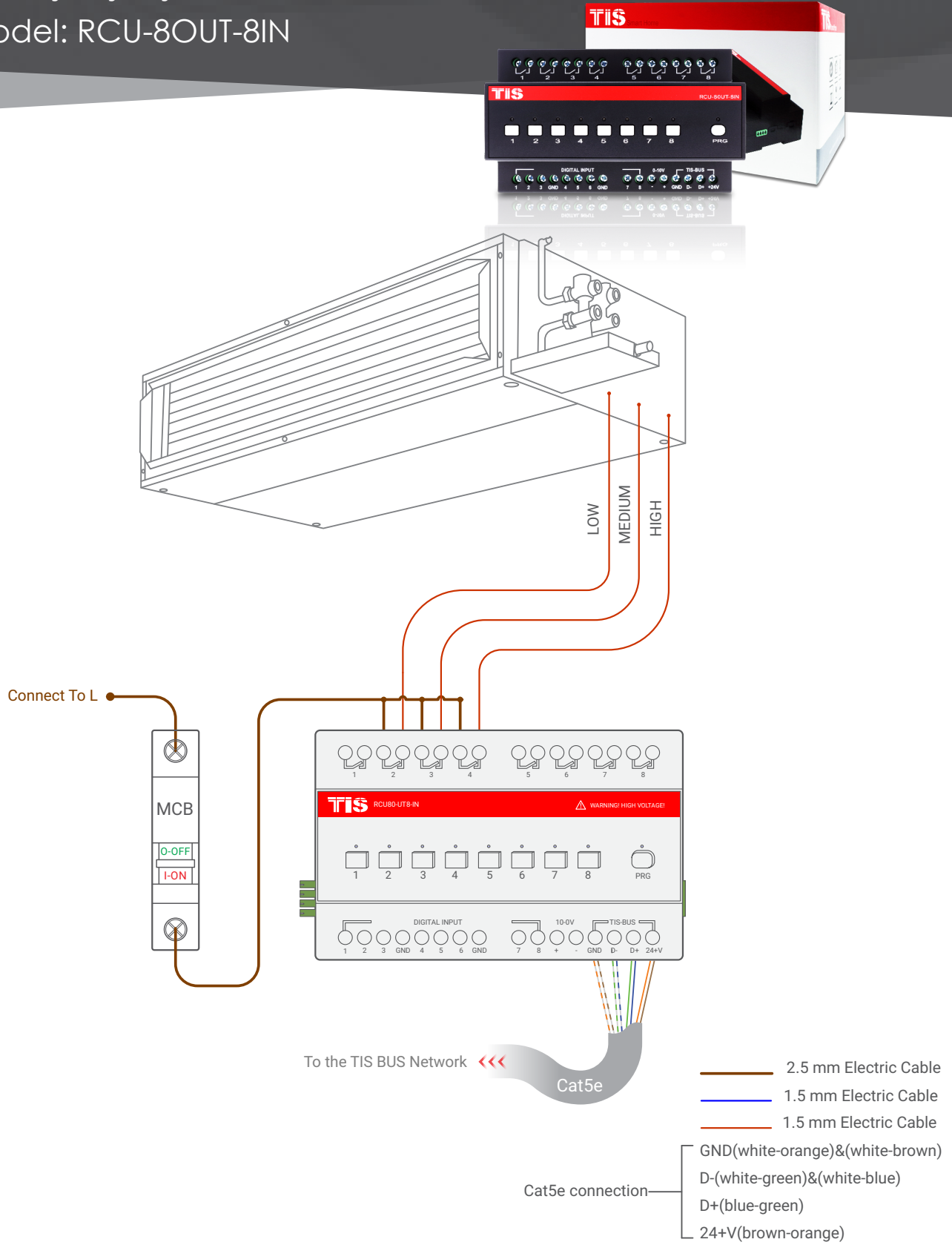

▲ Figure 1: FCU Bağlantı Diyagramı

TIS

Copyright © 2020 TIS, All Rights Reserved  
TIS Logo is a Registered Trademark of Texas Intelligent System LLC in the United States of America. This company takes TIS Control Ltd. in other countries. All of the Specifications are subject to change without notice.

TEXAS INTELLIGENT SYSTEM LLC  
SUITE# 610. 860 NORTH DOROTHY DR  
RICHARDSON  
TX 75081.USA

TIS CONTROL TÜRKİYE  
DEMİRCİKARA MAH. B. ONAT CAD.  
1419.SK OCEAN CITY SİTESİ B BLOK  
KAT:2 D:3 MURATPASA/ANTALYA

# ODA KONTROL ÜNİTESİ-RCU

8 GİRİŞ 8 ÇIKIŞ

Model: RCU-8OUT-8IN

TIS

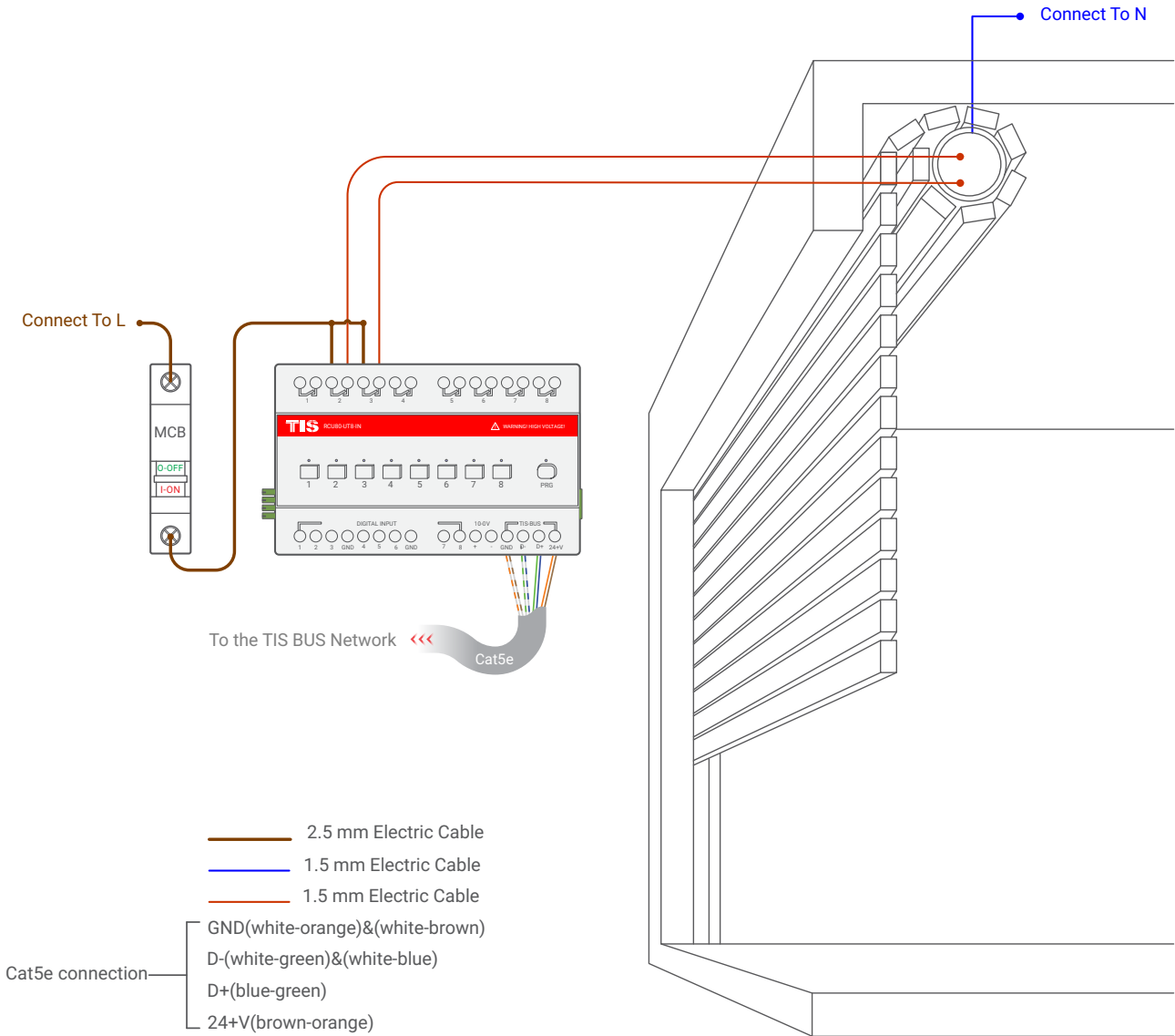

## ▲ Motor Bağlantı Diyagramı

TIS

Copyright © 2020 TIS, All Rights Reserved

TIS Logo is a Registered Trademark of Texas Intelligent System LLC in the United States of America. This company takes TIS Control Ltd. in other countries. All of the Specifications are subject to change without notice.

TEXAS INTELLIGENT SYSTEM LLC

SUITE# 610, 860 NORTH DOROTHY DR  
RICHARDSON  
TX 75081,USA

TIS CONTROL TÜRKİYE

DEMİRCİKARA MAH. B. ONAT CAD.  
1419.SK OCEAN CITY SİTESİ B BLOK  
KAT:2 D:3 MURATPAŞA/ANTALYA

# ODA KONTROL ÜNİTESİ-RCU

8 GİRİŞ 8 ÇIKIŞ

Model: RCU-8OUT-8IN

TIS

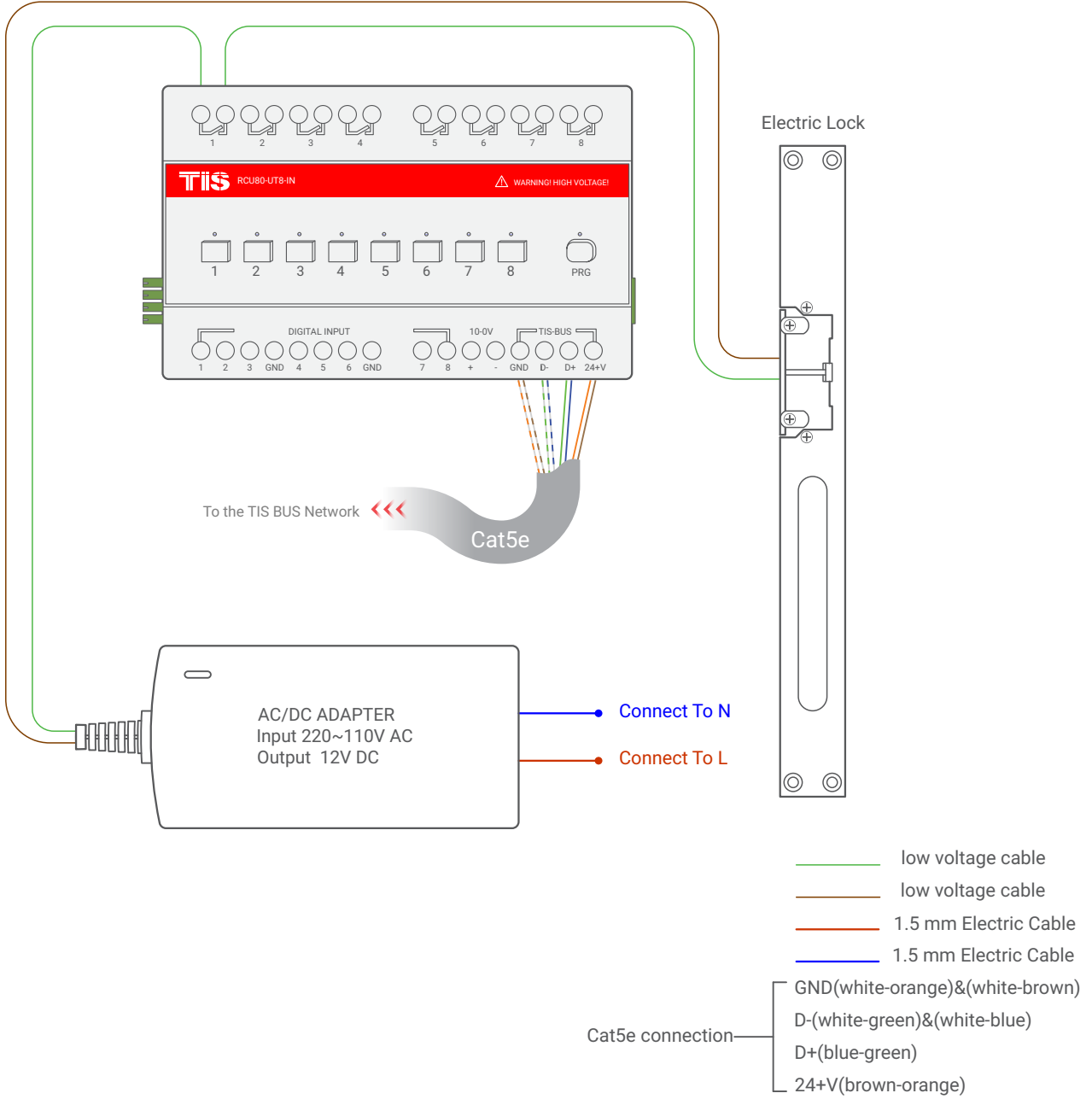

## ▲ Elektrik Kilidi Bağlantı Diyagramı

TIS

Copyright © 2020 TIS, All Rights Reserved  
TIS Logo is a Registered Trademark of Texas Intelligent System LLC in the United States of America. This company takes TIS Control Ltd. in other countries. All of the Specifications are subject to change without notice.

TEXAS INTELLIGENT SYSTEM LLC  
SUITE# 610. 860 NORTH DOROTHY DR  
RICHARDSON  
TX 75081.USA

TIS CONTROL TÜRKİYE  
DEMİRCİKARA MAH. B. ONAT CAD.  
1419.SK OCEAN CITY SİTESİ B BLOK  
KAT:2 D:3 MURATPAŞA/ANTALYA

# ODA KONTROL ÜNİTESİ-RCU

8 GİRİŞ 8 ÇIKIŞ

Model: RCU-8OUT-8IN

TIS

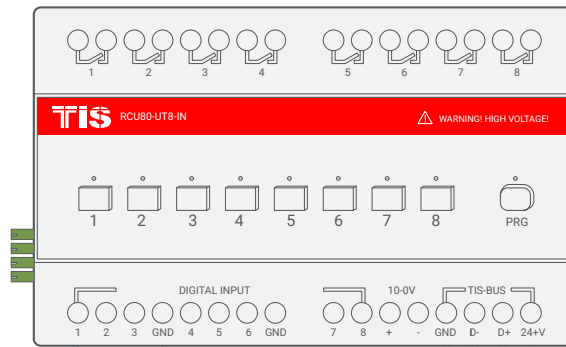

For 3<sup>rd</sup> party sensors

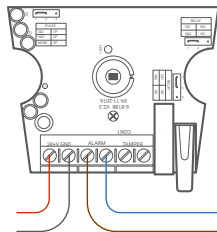

TO THE POWER SUPPLY

To the TIS BUS Network

Cat5e

- low voltage cable
- low voltage cable
- low voltage cable
- low voltage cable

- Cat5e connection
- GND(white-orange)&(white-brown)
  - D-(white-green)&(white-blue)
  - D+(blue-green)
  - 24+V(brown-orange)

## ▲ Harici Sensör Bağlantı Diyagramı

TIS

Copyright © 2020 TIS, All Rights Reserved

TIS Logo is a Registered Trademark of Texas Intelligent System LLC in the United States of America. This company takes TIS Control Ltd. in other countries. All of the Specifications are subject to change without notice.

TEXAS INTELLIGENT SYSTEM LLC

SUITE# 610, 860 NORTH DOROTHY DR  
RICHARDSON  
TX 75081,USA

TIS CONTROL TÜRKİYE

DEMİRCİKARA MAH. B. ONAT CAD.  
1419.SK OCEAN CITY SİTESİ B BLOK  
KAT:2 D:3 MURATPAŞA/ANTALYA

# ODA KONTROL ÜNİTESİ-RCU

8 GİRİŞ 8 ÇIKIŞ

Model: RCU-8OUT-8IN

TIS

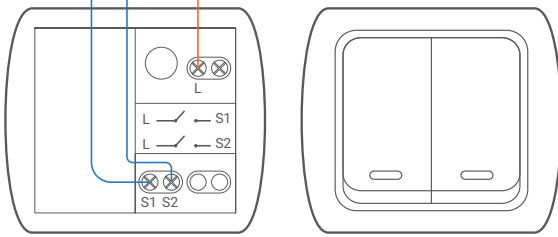
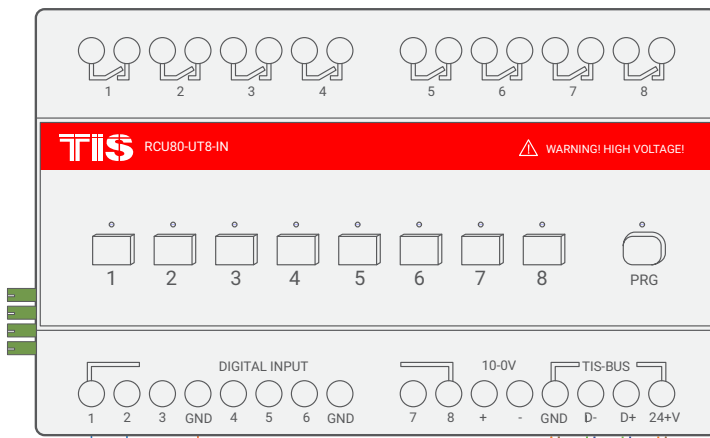

Traditional Switch



- Cat5e connection
- low voltage cable
  - low voltage cable
  - GND(white-orange)&(white-brown)
  - D-(white-green)&(white-blue)
  - D+(blue-green)
  - 24+V(brown-orange)

## ▲ Klasik Aydınlatma Anahtarı Bağlantı Diyagramı

TIS

Copyright © 2020 TIS, All Rights Reserved

TIS Logo is a Registered Trademark of Texas Intelligent System LLC in the United States of America. This company takes TIS Control Ltd. in other countries. All of the Specifications are subject to change without notice.

TEXAS INTELLIGENT SYSTEM LLC  
SUITE# 610. 860 NORTH DOROTHY DR  
RICHARDSON  
TX 75081.USA

TIS CONTROL TÜRKİYE  
DEMİRCİKARA MAH. B. ONAT CAD.  
1419.SK OCEAN CITY SİTESİ B BLOK  
KAT:2 D:3 MURATPAŞA/ANTALYA



# ODA KONTROL ÜNİTESİ-RCU

8 GİRİŞ 8 ÇIKIŞ

Model: RCU-8OUT-8IN

TIS

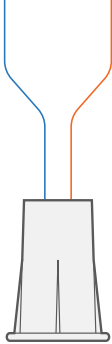
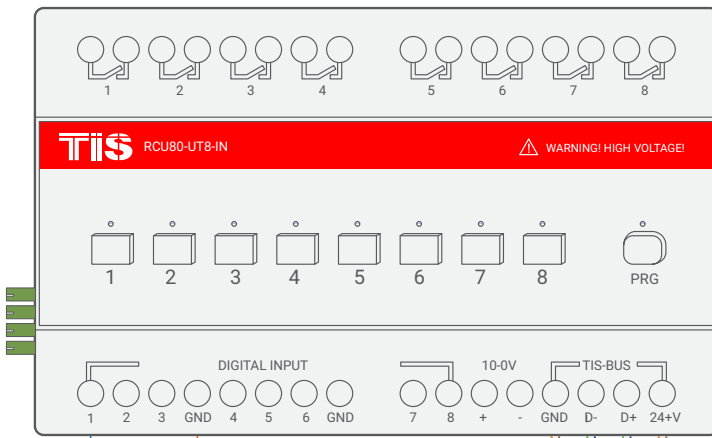

Door Magnet Contact

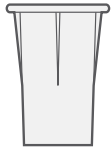

low voltage cable

low voltage cable

Cat5e connection

- GND(white-orange)&(white-brown)
- D-(white-green)&(white-blue)
- D+(blue-green)
- 24+V(brown-orange)

## ▲ Manyetik Kontak Kapı Bağlantı Diyagramı

TIS

Copyright © 2020 TIS, All Rights Reserved

TIS Logo is a Registered Trademark of Texas Intelligent System LLC in the United States of America. This company takes TIS Control Ltd. in other countries. All of the Specifications are subject to change without notice.

TEXAS INTELLIGENT SYSTEM LLC

SUITE# 610. 860 NORTH DOROTHY DR  
RICHARDSON  
TX 75081.USA

TIS CONTROL TÜRKİYE

DEMİRCİKARA MAH. B. ONAT CAD.  
1419.SK OCEAN CITY SİTESİ B BLOK  
KAT:2 D:3 MURATPAŞA/ANTALYA



# ODA KONTROL ÜNİTESİ-RCU

8 GİRİŞ 8 ÇIKIŞ

Model: RCU-8OUT-8IN

TIS

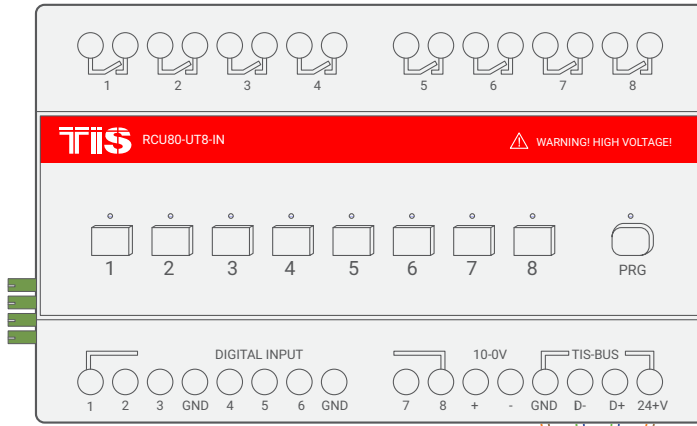

- Cat5e connection
- GND(white-orange)&(white-brown)
  - D-(white-green)&(white-blue)
  - D+(blue-green)
  - 24+V(brown-orange)

## ▲ Bus Bağlantı Renk Kodları

TIS

Copyright © 2020 TIS, All Rights Reserved  
TIS Logo is a Registered Trademark of Texas Intelligent System LLC in the United States of America. This company takes TIS Control Ltd. in other countries. All of the Specifications are subject to change without notice.

TEXAS INTELLIGENT SYSTEM LLC  
SUITE# 610. 860 NORTH DOROTHY DR  
RICHARDSON  
TX 75081.USA

TIS CONTROL TÜRKİYE  
DEMİRCİKARA MAH. B. ONAT CAD.  
1419.SK OCEAN CITY SİTESİ B BLOK  
KAT:2 D:3 MURATPASA/ANTALYA

# ODA KONTROL ÜNİTESİ-RCU

8 GİRİŞ 8 ÇIKIŞ

Model: RCU-8OUT-8IN

TIS

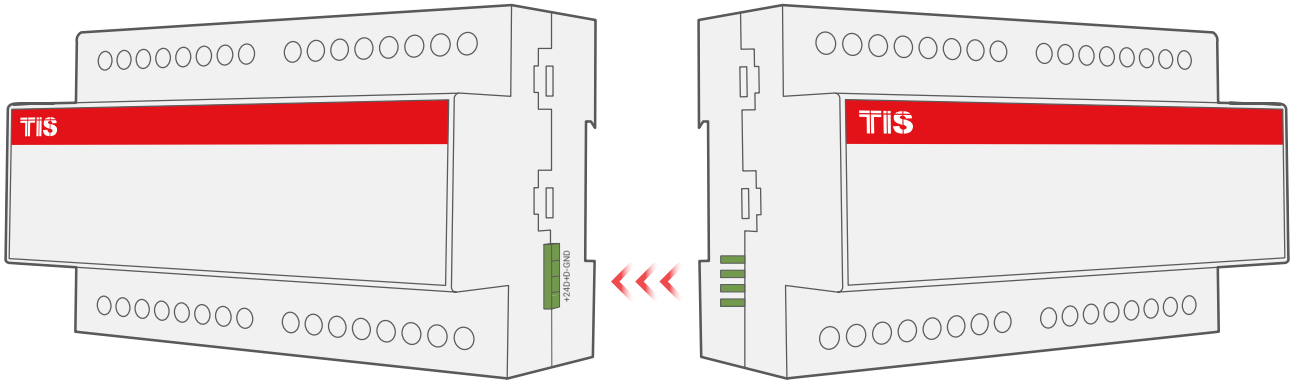

## ▲ DIN-Ray Modül Bağlantısı

TIS

Copyright © 2020 TIS, All Rights Reserved

TIS Logo is a Registered Trademark of Texas Intelligent System LLC in the United States of America. This company takes TIS Control Ltd. in other countries. All of the Specifications are subject to change without notice.

TEXAS INTELLIGENT SYSTEM LLC

SUITE# 610, 860 NORTH DOROTHY DR  
RICHARDSON  
TX 75081,USA

TIS CONTROL TÜRKİYE

DEMİRCİKARA MAH. B. ONAT CAD.  
1419.SK OCEAN CITY SİTESİ B BLOK  
KAT:2 D:3 MURATPASA/ANTALYA

# ODA KONTROL ÜNİTESİ-RCU

8 GİRİŞ 8 ÇIKIŞ

Model: RCU-8OUT-8IN

TIS

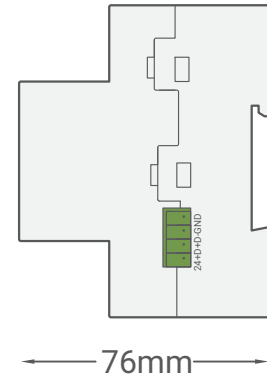
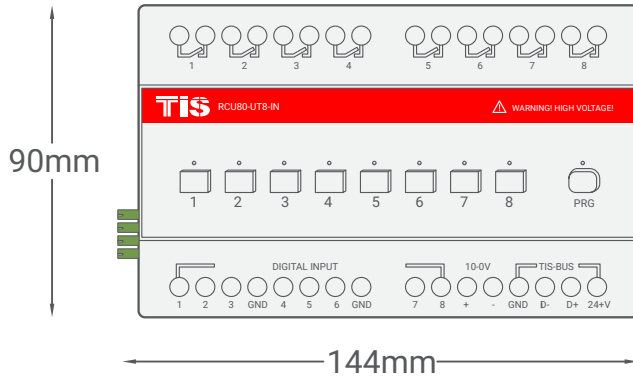

## ▲ Modül Boyutları

TIS

Copyright © 2020 TIS, All Rights Reserved  
TIS Logo is a Registered Trademark of Texas Intelligent System LLC in the United States of America. This company takes TIS Control Ltd. in other countries. All of the Specifications are subject to change without notice.

TEXAS INTELLIGENT SYSTEM LLC  
SUITE# 610, 860 NORTH DOROTHY DR  
RICHARDSON  
TX 75081.USA

TIS CONTROL TÜRKİYE  
DEMİRCİKARA MAH. B. ONAT CAD.  
1419.SK OCEAN CITY SİTESİ B BLOK  
KAT:2 D:3 MURATPAŞA/ANTALYA