

▲ Mars 4G ve ADD-3R-5A Aydınlatma Bağlantı Diyagramı

# TIS MARS 4G PANEL

4 Butonlu Panel

Model: MRS-4G

# TIS

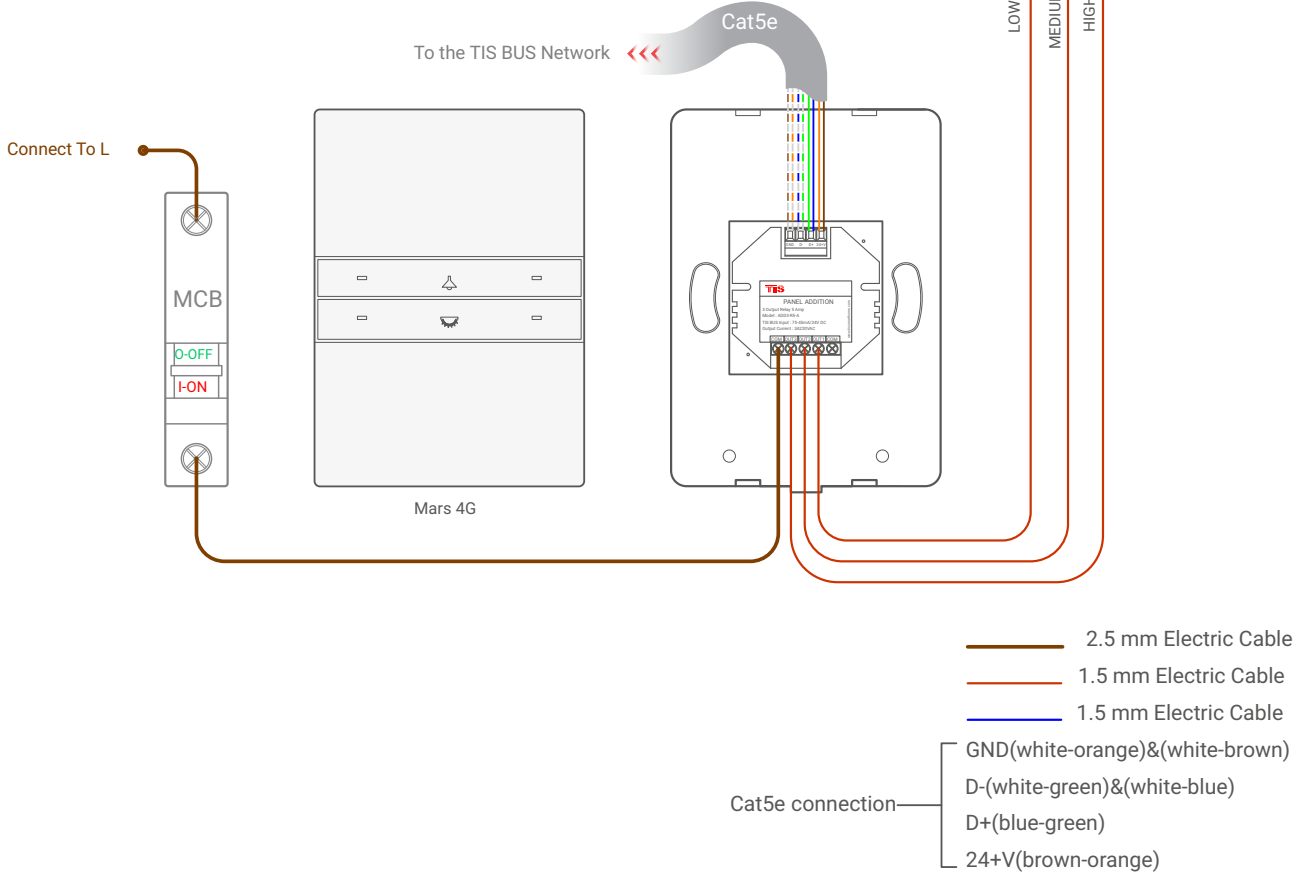
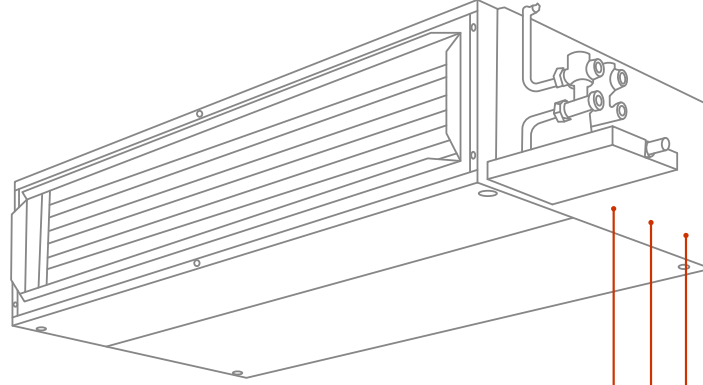
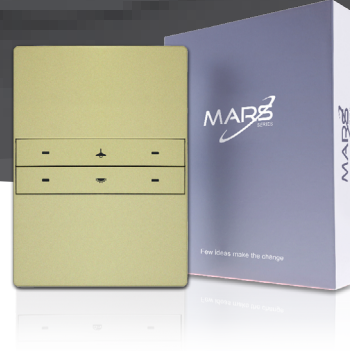

## ▲ Mars 4G ve ADD-3R-5A FCU Bağlantı Diyagramı

# TIS

Copyright © 2020 TIS, All Rights Reserved

TIS Logo is a Registered Trademark of Texas Intelligent System LLC in the United States of America. This company takes TIS Control Ltd. in other countries. All of the Specifications are subject to change without notice.

TEXAS INTELLIGENT SYSTEM LLC

SUITE# 610, 860 NORTH DOROTHY DR  
RICHARDSON  
TX 75081.USA

TIS CONTROL TÜRKİYE

DEMİRCİKARA MAH. B. ONAT CAD.  
1419.SK OCEAN CITY SİTESİ B BLOK  
KAT:2 D:3 MURATPAŞA/ANTALYA

# TIS MARS 4G PANEL

4 Butonlu Panel

Model: MRS-4G

# TIS

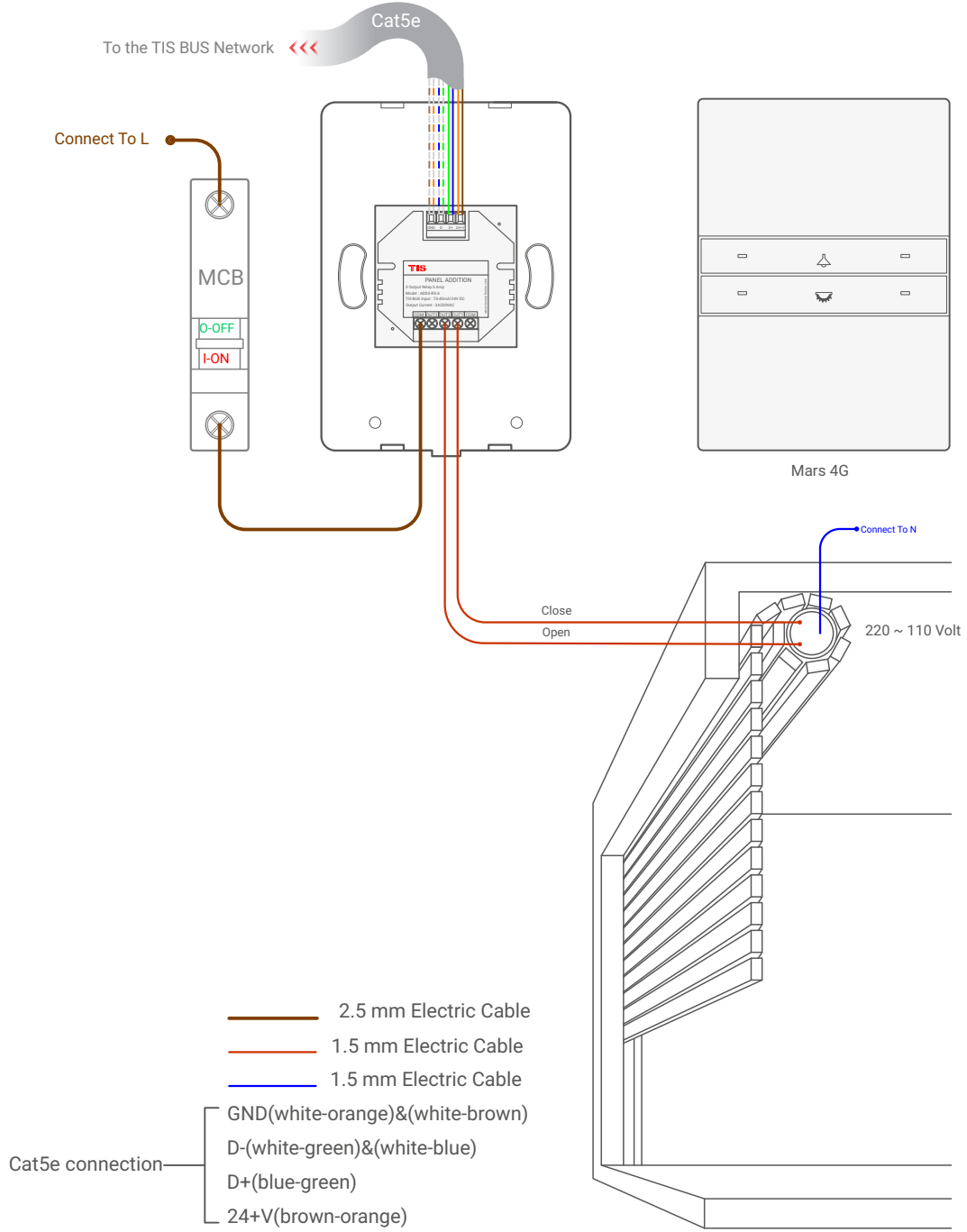
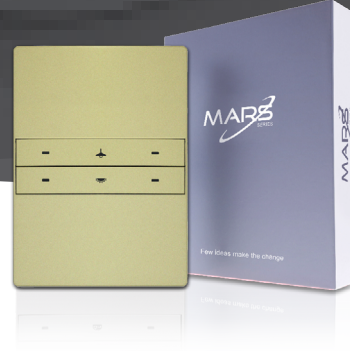

## ▲ Mars 4G ve ADD-3R-5A Motor Bağlantı Diyagramı

# TIS

Copyright © 2020 TIS, All Rights Reserved

TIS Logo is a Registered Trademark of Texas Intelligent System LLC in the United States of America. This company takes TIS Control Ltd. in other countries. All of the Specifications are subject to change without notice.

TEXAS INTELLIGENT SYSTEM LLC  
SUITE# 610, 860 NORTH DOROTHY DR  
RICHARDSON  
TX 75081,USA

TIS CONTROL TÜRKİYE  
DEMİRCİKARA MAH. B. ONAT CAD.  
1419.SK OCEAN CITY SİTESİ B BLOK  
KAT:2 D:3 MURATPAŞA/ANTALYA

# TIS MARS 4G PANEL

4 Butonlu Panel

Model: MRS-4G

TIS

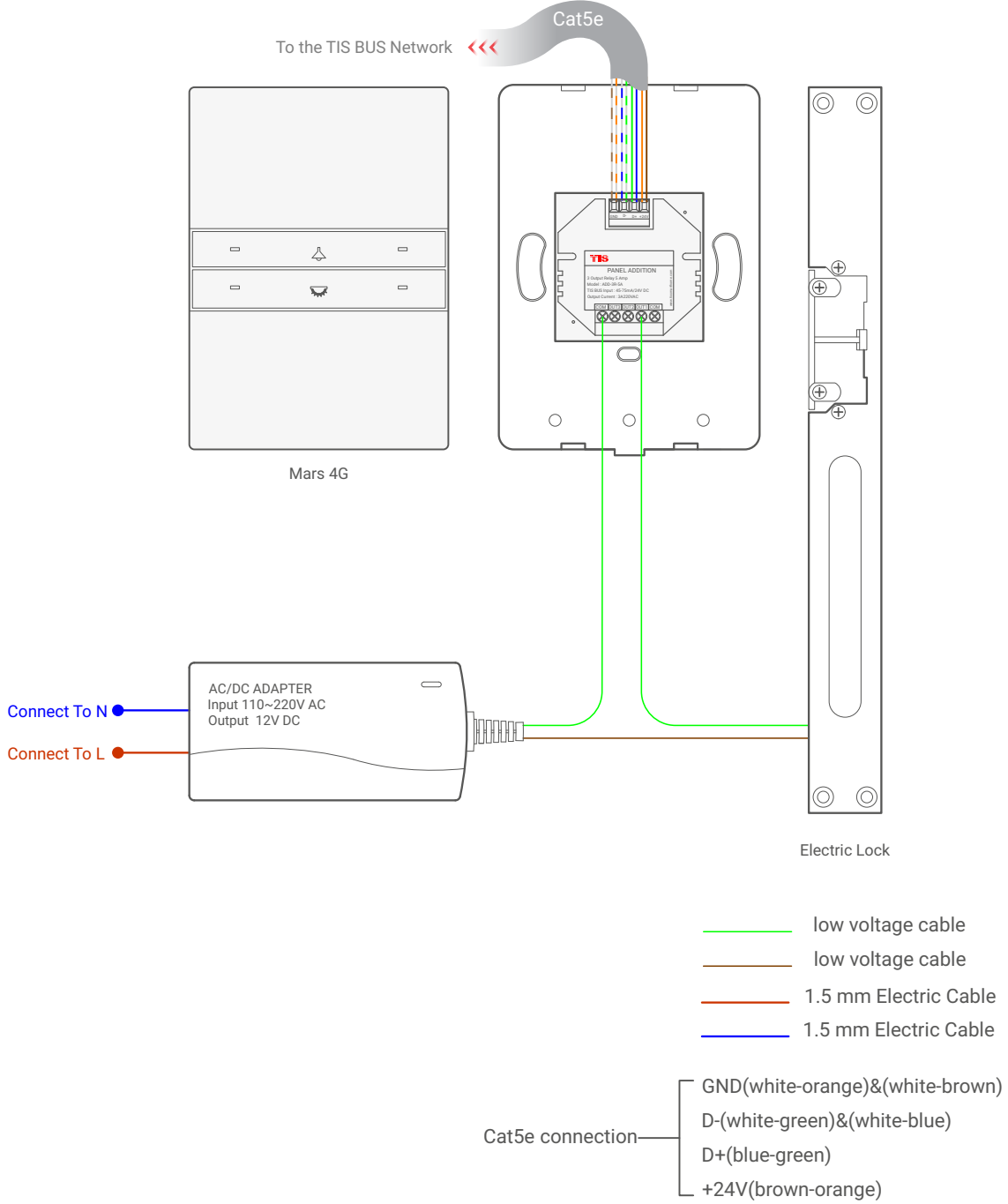

## ▲ Mars 4G ve ADD-3R-5A Elektrik Kilidi Bağlantı Diyagramı

TIS

Copyright © 2020 TIS, All Rights Reserved  
TIS Logo is a Registered Trademark of Texas Intelligent System LLC in the United States of America. This company takes TIS Control Ltd. in other countries. All of the Specifications are subject to change without notice.

TEXAS INTELLIGENT SYSTEM LLC  
SUITE# 610, 860 NORTH DOROTHY DR  
RICHARDSON  
TX 75081.USA

TIS CONTROL TÜRKİYE  
DEMİRCİKARA MAH. B. ONAT CAD.  
1419.SK OCEAN CITY SİTESİ B BLOK  
KAT:2 D:3 MURATPAŞA/ANTALYA

# TIS MARS 4G PANEL

4 Butonlu Panel

Model: MRS-4G

# TIS

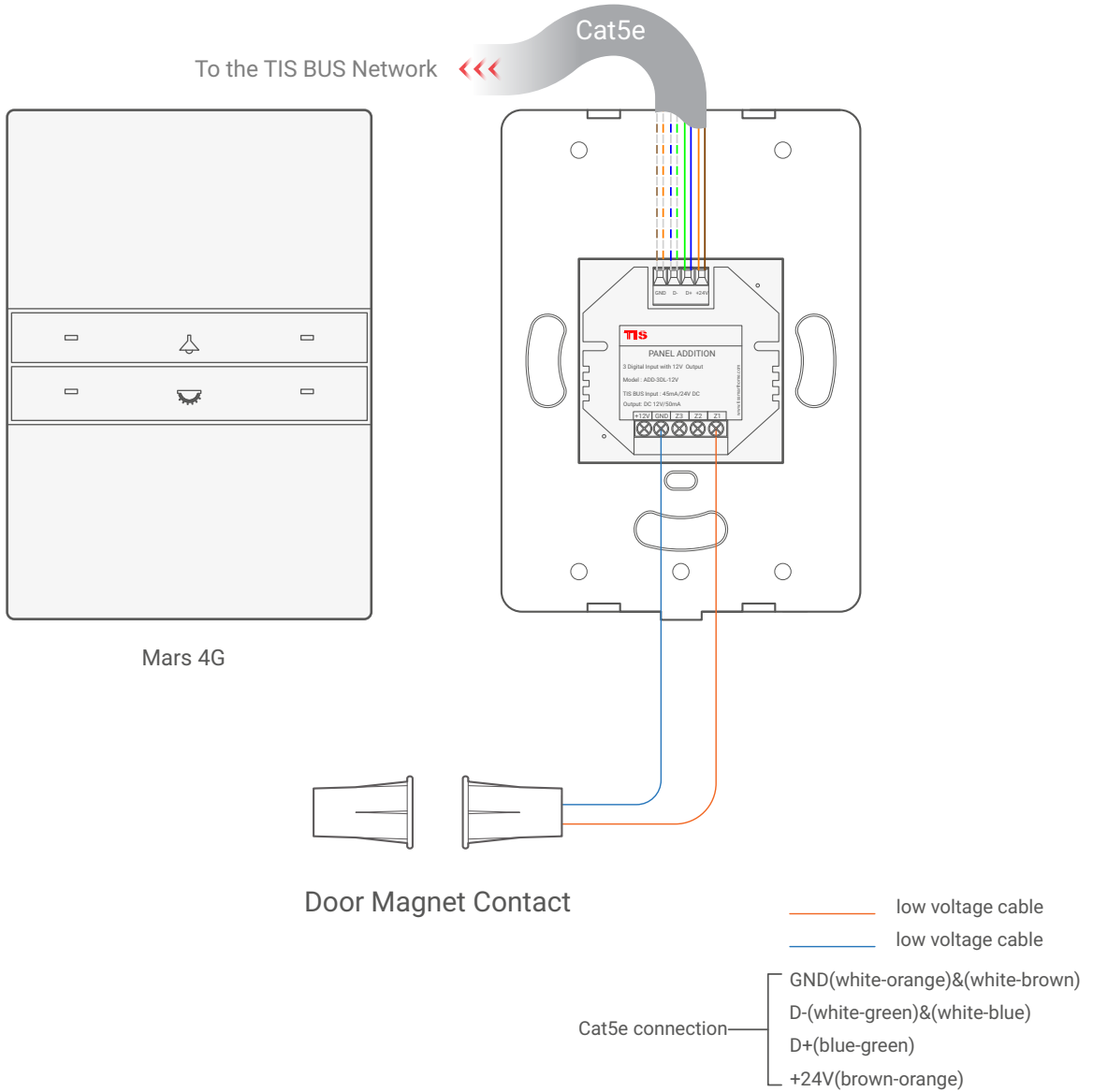

## ▲ Mars 4G ve ADD-3DL-12V Manyetik Kontak Kapı Bağlantı Diyagramı

# TIS

Copyright © 2020 TIS, All Rights Reserved  
TIS Logo is a Registered Trademark of Texas Intelligent System LLC in the United States of America. This company takes TIS Control Ltd. in other countries. All of the Specifications are subject to change without notice.

TEXAS INTELLIGENT SYSTEM LLC  
SUITE# 610, 860 NORTH DOROTHY DR  
RICHARDSON  
TX 75081.USA

TIS CONTROL TÜRKİYE  
DEMİRCİKARA MAH. B. ONAT CAD.  
1419.SK OCEAN CITY SİTESİ B BLOK  
KAT:2 D:3 MURATPAŞA/ANTALYA

# TIS MARS 4G PANEL

4 Butonlu Panel

Model: MRS-4G

# TIS

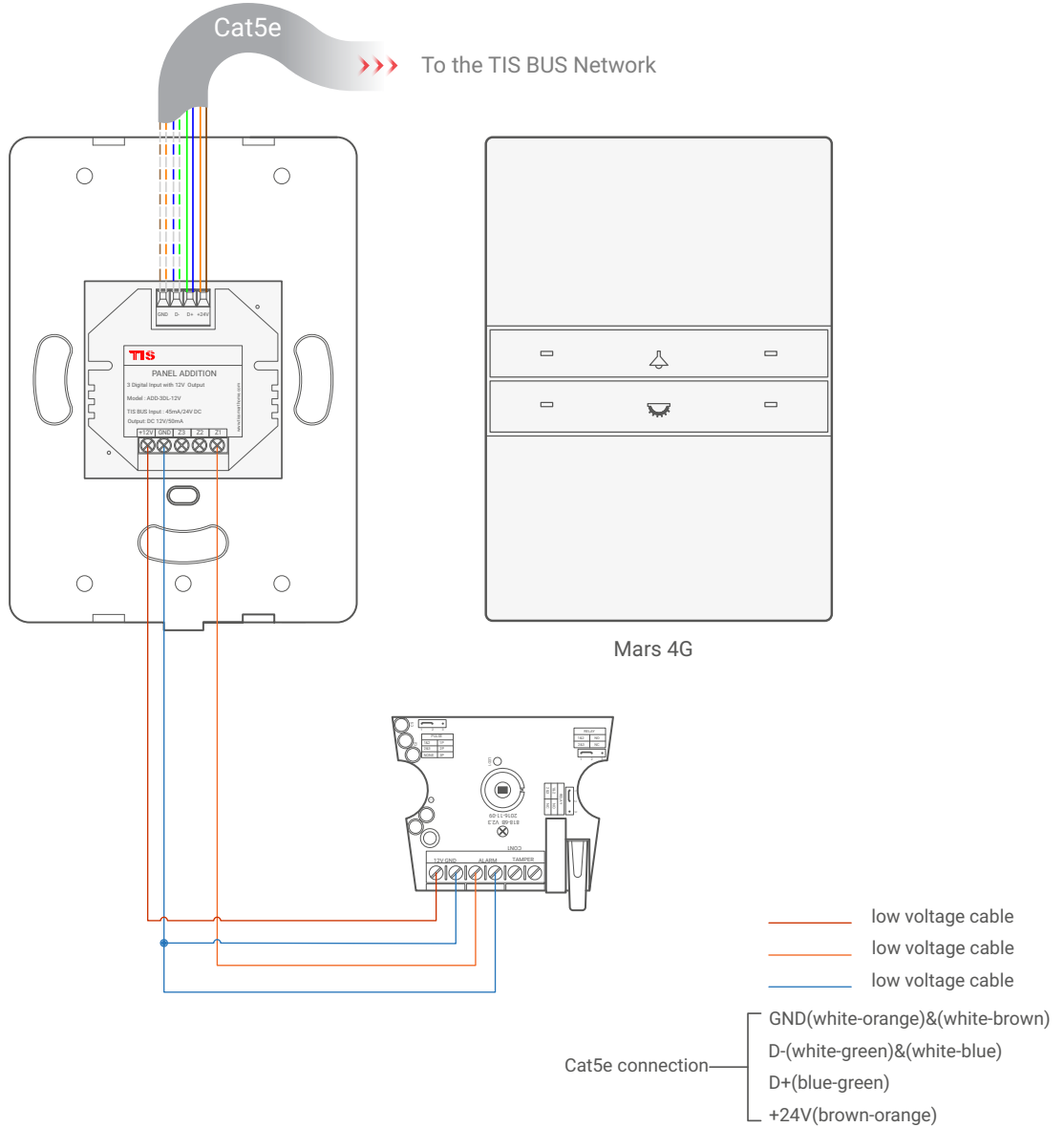
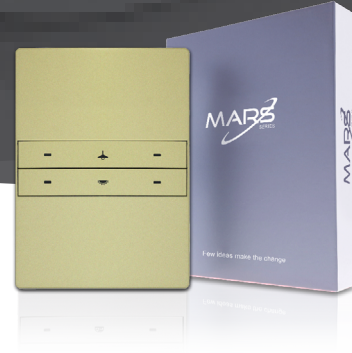

## ▲ Mars 4G ve ADD-3DL-12V Harici Sensör Bağlantı Diyagramı

# TIS

Copyright © 2020 TIS. All Rights Reserved  
TIS Logo is a Registered Trademark of Texas Intelligent System LLC in the United States of America. This company takes TIS Control Ltd. in other countries. All of the Specifications are subject to change without notice.

TEXAS INTELLIGENT SYSTEM LLC  
SUITE# 610. 860 NORTH DOROTHY DR  
RICHARDSON  
TX 75081.USA

TIS CONTROL TÜRKİYE  
DEMİRCİKARA MAH. B. ONAT CAD.  
1419.SK OCEAN CITY SİTESİ B BLOK  
KAT:2 D:3 MURATPAŞA/ANTALYA

# TIS MARS 4G PANEL

4 Butonlu Panel

Model: MRS-4G

# TIS

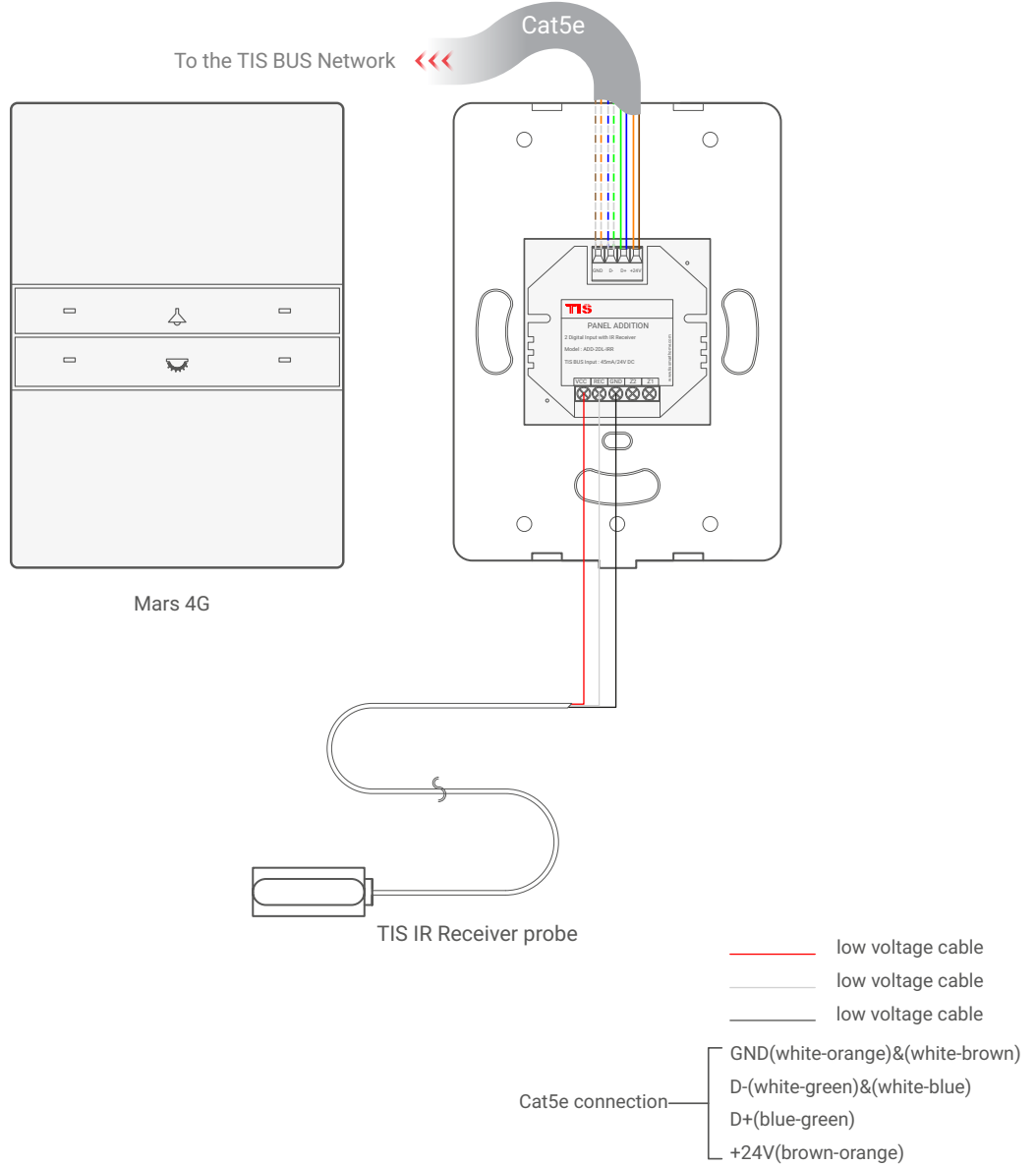

## ▲ Mars 4G ve ADD-2DL-IRR Alıcı Göz Bağlantı Diyagramı

# TIS

Copyright © 2020 TIS, All Rights Reserved  
TIS Logo is a Registered Trademark of Texas Intelligent System LLC in the United States of America. This company takes TIS Control Ltd. in other countries. All of the Specifications are subject to change without notice.

TEXAS INTELLIGENT SYSTEM LLC  
SUITE# 610. 860 NORTH DOROTHY DR  
RICHARDSON  
TX 75081.USA

TIS CONTROL TÜRKİYE  
DEMİRCİKARA MAH. B. ONAT CAD.  
1419.SK OCEAN CITY SİTESİ B BLOK  
KAT:2 D:3 MURATPAŞA/ANTALYA

# TIS MARS 4G PANEL

4 Butonlu Panel

Model: MRS-4G

# TIS

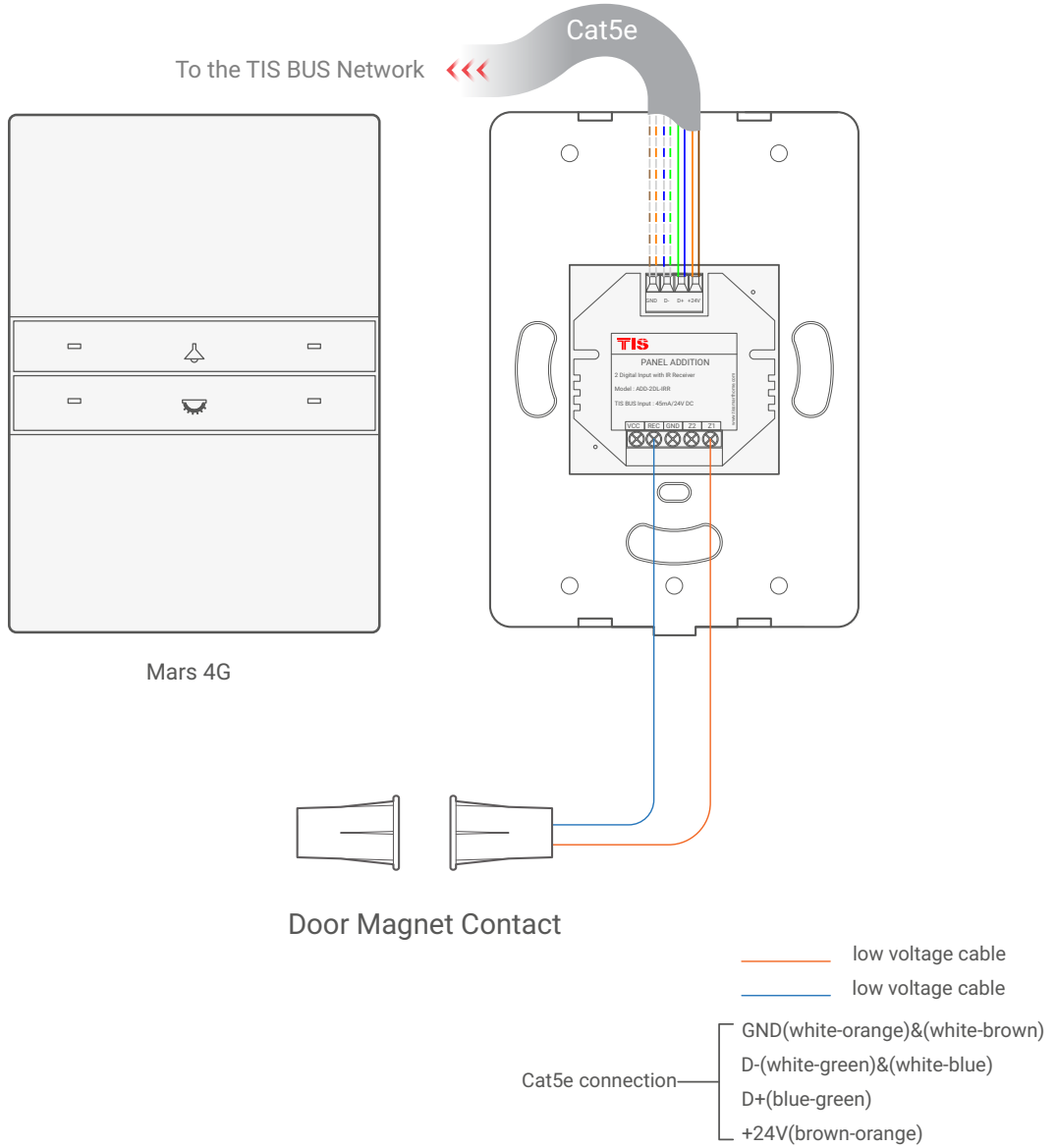
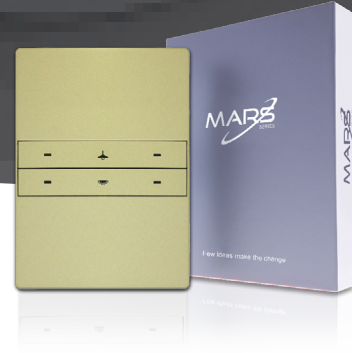

## ▲ Mars 4G & ADD-2DL-IRR Manyetik Kontak Kapı Bağlantı Diyagramı

# TIS

Copyright © 2020 TIS, All Rights Reserved

TIS Logo is a Registered Trademark of Texas Intelligent System LLC in the United States of America. This company takes TIS Control Ltd. in other countries. All of the Specifications are subject to change without notice.

TEXAS INTELLIGENT SYSTEM LLC

SUITE# 610. 860 NORTH DOROTHY DR  
RICHARDSON  
TX 75081.USA

TIS CONTROL TÜRKİYE  
DEMİRCİKARA MAH. B. ONAT CAD.  
1419.SK OCEAN CITY SİTESİ B BLOK  
KAT:2 D:3 MURATPAŞA/ANTALYA



# TIS MARS 4G PANEL

4 Butonlu Panel

Model: MRS-4G

# TIS

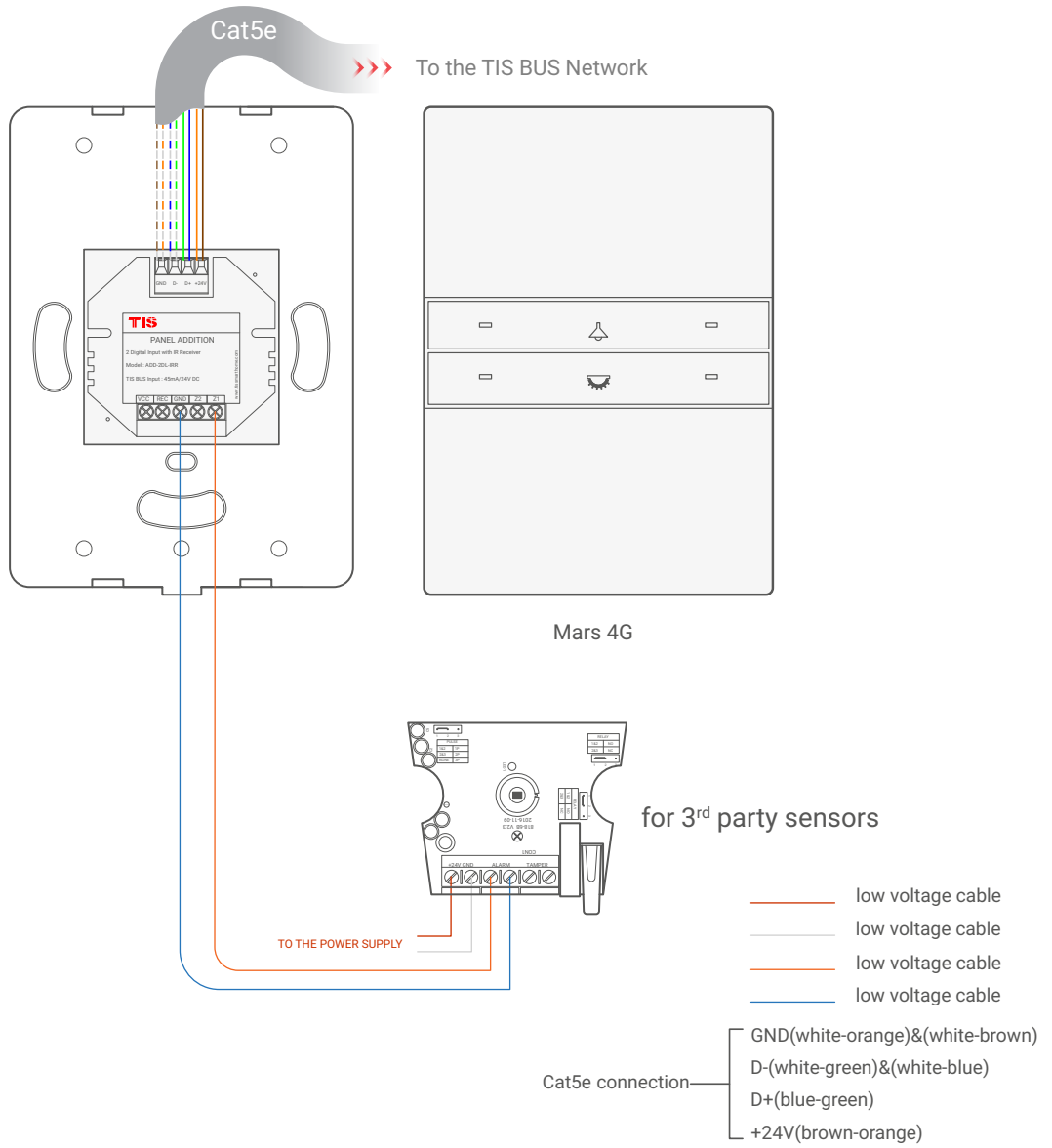
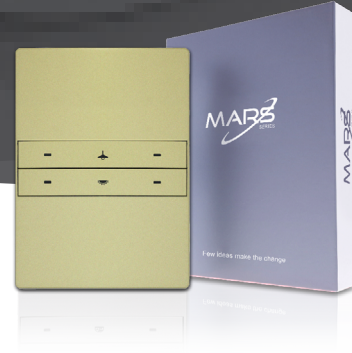

## ▲ Mars 4G ve ADD-2DL-IRR Harici Sensör Bağlantı Diyagramı

# TIS

Copyright © 2020 TIS, All Rights Reserved

TIS Logo is a Registered Trademark of Texas Intelligent System LLC in the United States of America. This company takes TIS Control Ltd. in other countries. All of the Specifications are subject to change without notice.

TEXAS INTELLIGENT SYSTEM LLC

SUITE# 610, 860 NORTH DOROTHY DR  
RICHARDSON  
TX 75081,USA

TIS CONTROL TÜRKİYE

DEMİRCİKARA MAH. B. ONAT CAD.  
1419.SK OCEAN CITY SİTESİ B BLOK  
KAT:2 D:3 MURATPAŞA/ANTALYA

# TIS MARS 4G PANEL

4 Butonlu Panel

Model: MRS-4G

# TIS

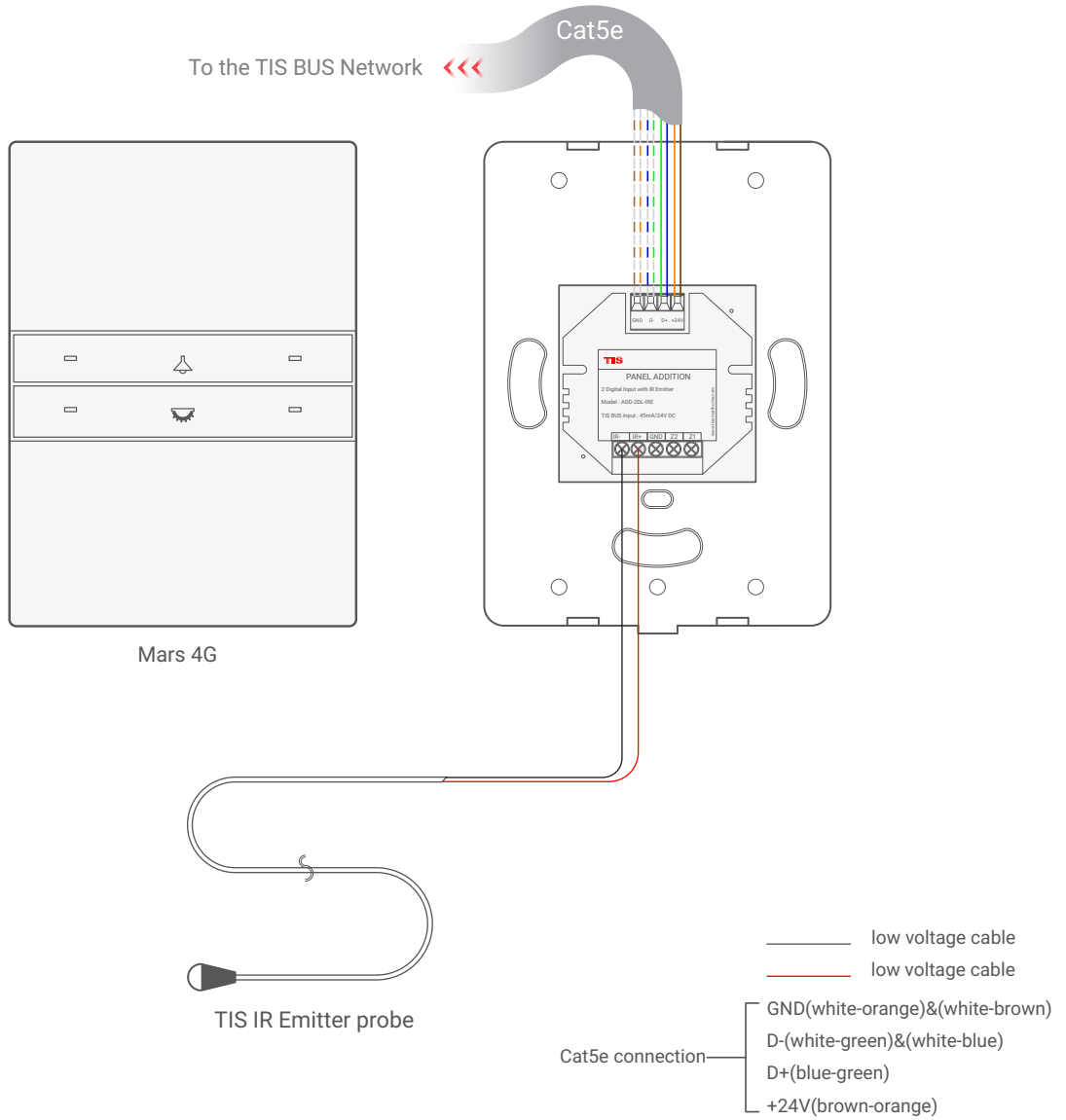
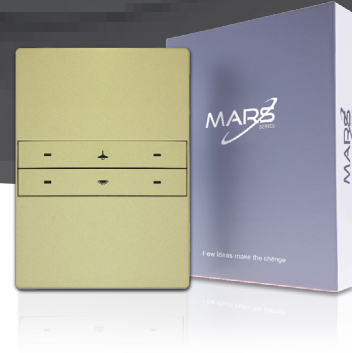

## ▲ Mars 4G ve ADD-2DL-IRE Verici Göz Bağlantı Diyagramı

# TIS

Copyright © 2020 TIS, All Rights Reserved

TIS Logo is a Registered Trademark of Texas Intelligent System LLC in the United States of America. This company takes TIS Control Ltd. in other countries. All of the Specifications are subject to change without notice.

TEXAS INTELLIGENT SYSTEM LLC

SUITE# 610. 860 NORTH DOROTHY DR  
RICHARDSON  
TX 75081.USA

TIS CONTROL TÜRKİYE

DEMİRCİKARA MAH. B. ONAT CAD.  
1419.SK OCEAN CITY SİTESİ B BLOK  
KAT:2 D:3 MURATPAŞA/ANTALYA

# TIS MARS 4G PANEL

4 Butonlu Panel

Model: MRS-4G

# TIS

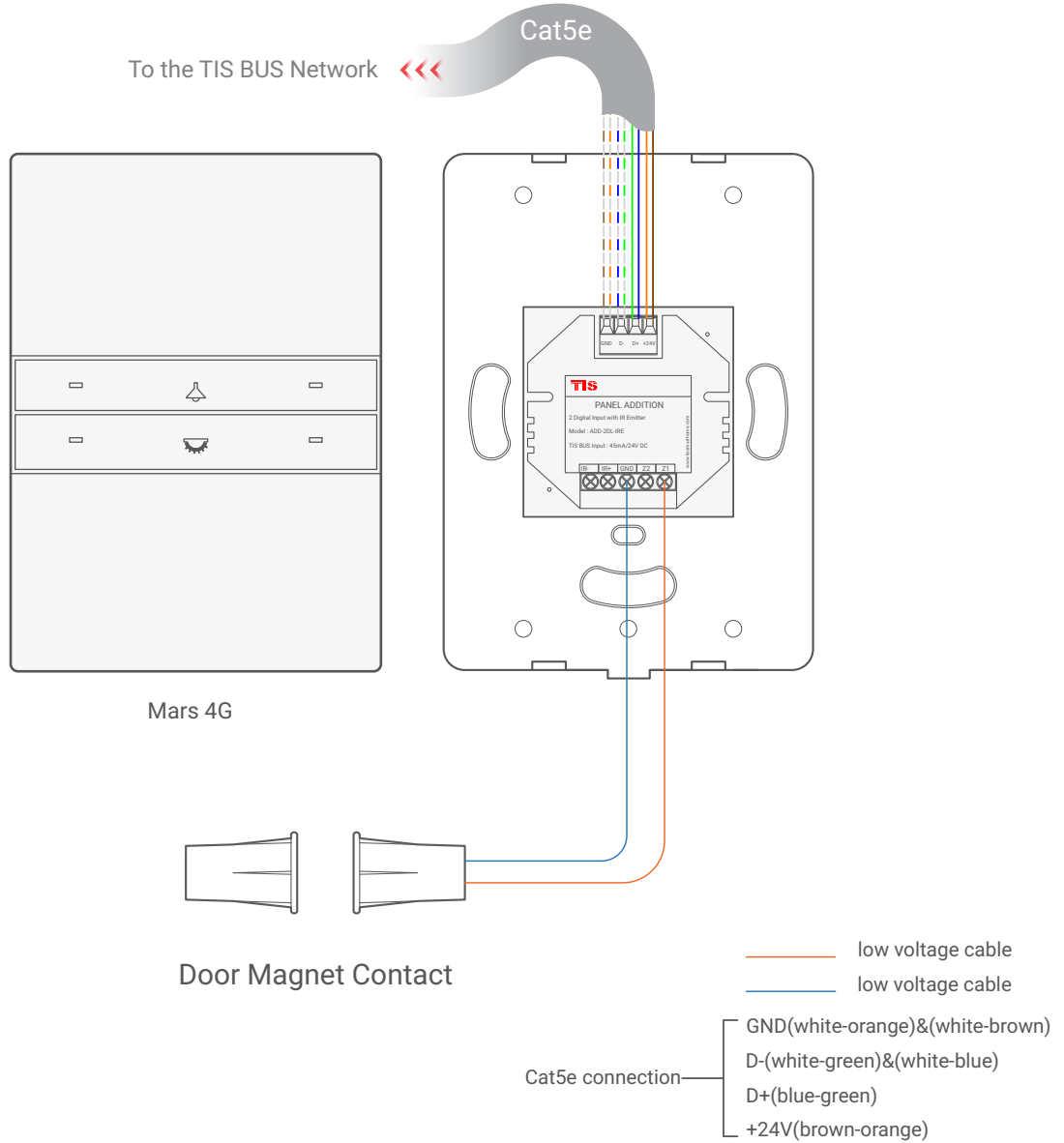

## ▲ Mars 4G ve ADD-2DL-IRE Manyetik Kontak Kapı Bağlantı Diyagramı

# TIS

Copyright © 2020 TIS, All Rights Reserved  
TIS Logo is a Registered Trademark of Texas Intelligent System LLC in the United States of America. This company takes TIS Control Ltd. in other countries. All of the Specifications are subject to change without notice.

TEXAS INTELLIGENT SYSTEM LLC  
SUITE# 610. 860 NORTH DOROTHY DR  
RICHARDSON  
TX 75081.USA

TIS CONTROL TÜRKİYE  
DEMİRCİKARA MAH. B. ONAT CAD.  
1419.SK OCEAN CITY SİTESİ B BLOK  
KAT:2 D:3 MURATPAŞA/ANTALYA

# TIS MARS 4G PANEL

4 Butonlu Panel

Model: MRS-4G

# TIS

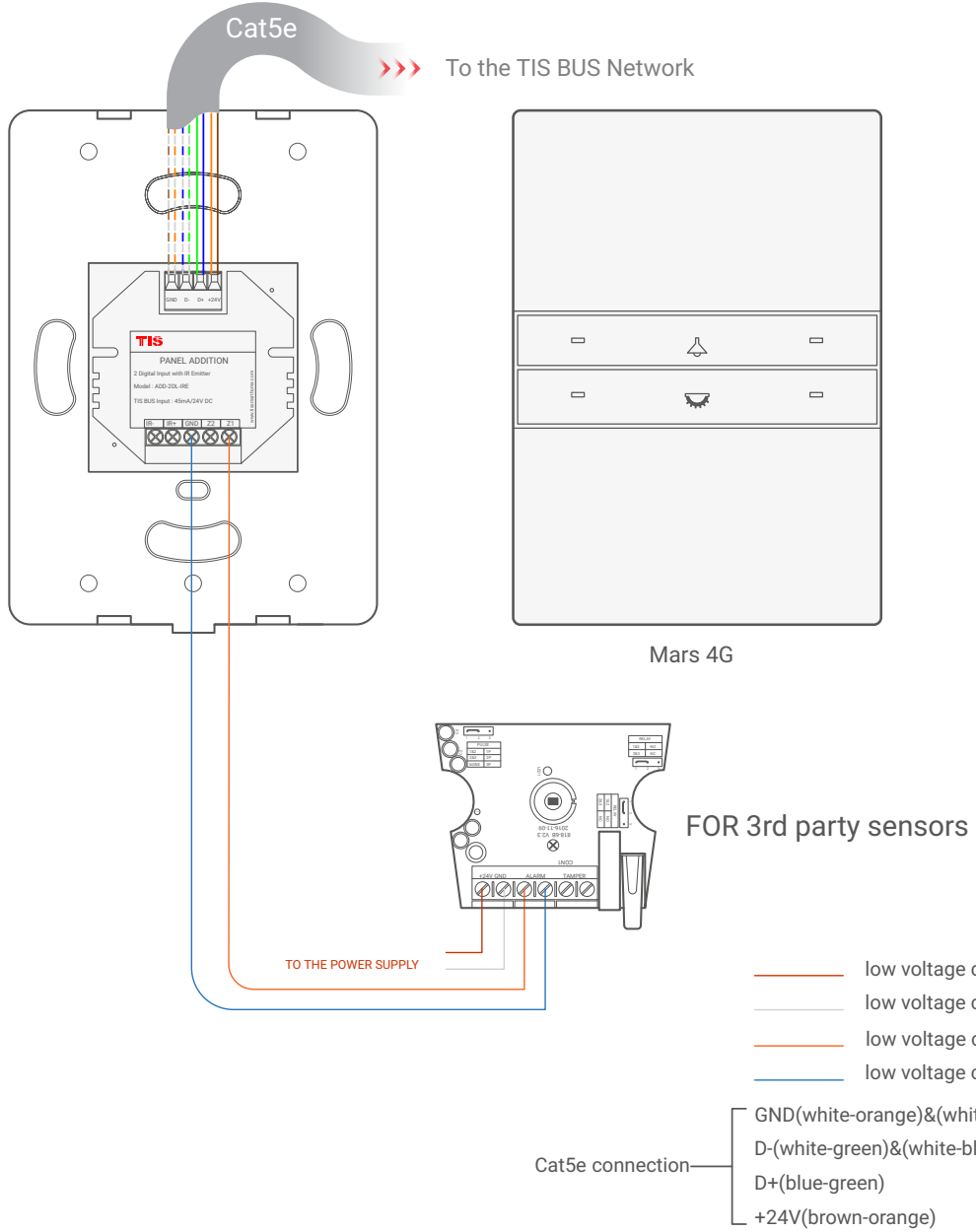
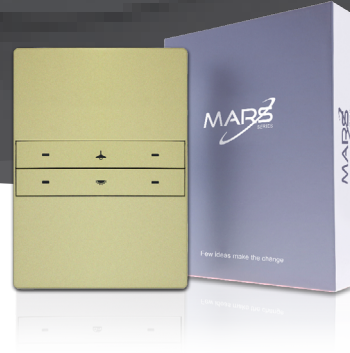

## ▲ Mars 4G ve ADD-2DL-IRE Harici Sensör Bağlantı Diyagramı

# TIS

Copyright © 2020 TIS, All Rights Reserved  
TIS Logo is a Registered Trademark of Texas Intelligent System LLC in the United States of America. This company takes TIS Control Ltd. in other countries. All of the Specifications are subject to change without notice.

TEXAS INTELLIGENT SYSTEM LLC  
SUITE# 610. 860 NORTH DOROTHY DR  
RICHARDSON  
TX 75081.USA

TIS CONTROL TÜRKİYE  
DEMİRCİKARA MAH. B. ONAT CAD.  
1419.SK OCEAN CITY SİTESİ B BLOK  
KAT:2 D:3 MURATPAŞA/ANTALYA

# TIS MARS 4G PANEL

4 Butonlu Panel

Model: MRS-4G

TIS



To the TIS BUS Network <<<<

Cat5e

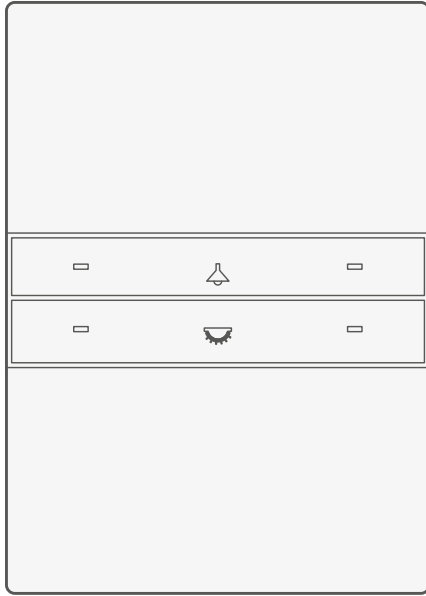

Mars 4G

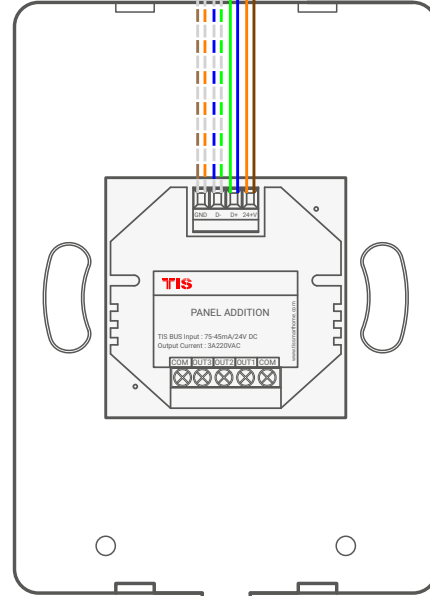

Cat5e connection

- GND(white-orange)&(white-brown)
- D-(white-green)&(white-blue)
- D+(blue-green)
- +24V(brown-orange)

## ▲ Bus Bağlantı Renk Kodları

TIS

Copyright © 2020 TIS, All Rights Reserved

TIS Logo is a Registered Trademark of Texas Intelligent System LLC in the United States of America. This company takes TIS Control Ltd. in other countries. All of the Specifications are subject to change without notice.

TEXAS INTELLIGENT SYSTEM LLC

SUITE# 610. 860 NORTH DOROTHY DR  
RICHARDSON  
TX 75081.USA

TIS CONTROL TÜRKİYE

DEMİRCİKARA MAH. B. ONAT CAD.  
1419.SK OCEAN CITY SİTESİ B BLOK  
KAT:2 D:3 MURATPAŞA/ANTALYA

# TIS MARS 4G PANEL

4 Butonlu Panel

Model: MRS-4G

TIS

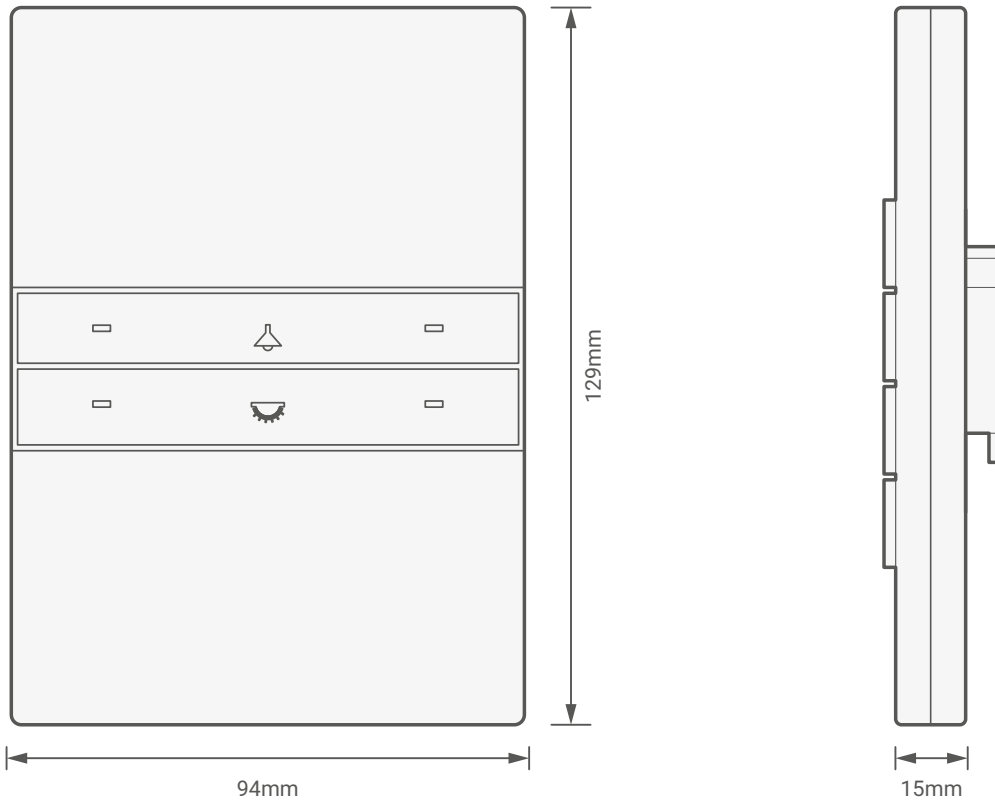
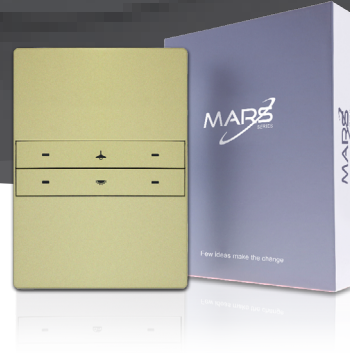

## ▲ Modül Boyut Diyagramı

TIS

Copyright © 2020 TIS, All Rights Reserved

TIS Logo is a Registered Trademark of Texas Intelligent System LLC in the United States of America. This company takes TIS Control Ltd. in other countries. All of the Specifications are subject to change without notice.

TEXAS INTELLIGENT SYSTEM LLC

SUITE# 610, 860 NORTH DOROTHY DR  
RICHARDSON  
TX 75081,USA

TIS CONTROL TÜRKİYE

DEMİRCİKARA MAH. B. ONAT CAD.  
1419.SK OCEAN CITY SİTESİ B BLOK  
KAT:2 D:3 MURATPAŞA/ANTALYA