

▲ Luna TFT ve ADD-3R-5A Aydınlatma Bağlantı Diyagramı

TIS LUNA TFT PANEL

4.3" Dokunmatik Panel

Model: LUNA-TFT43

TIS

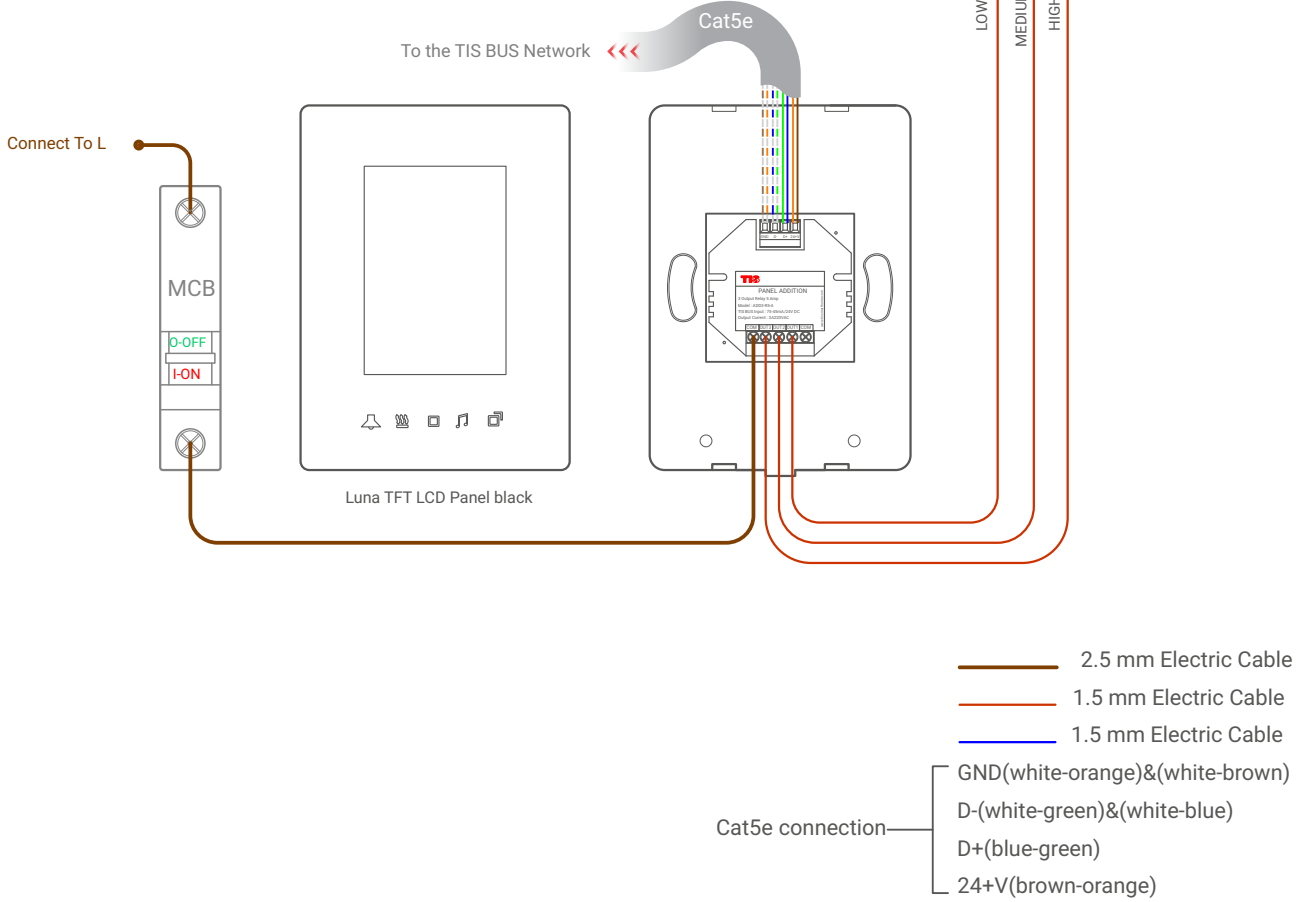
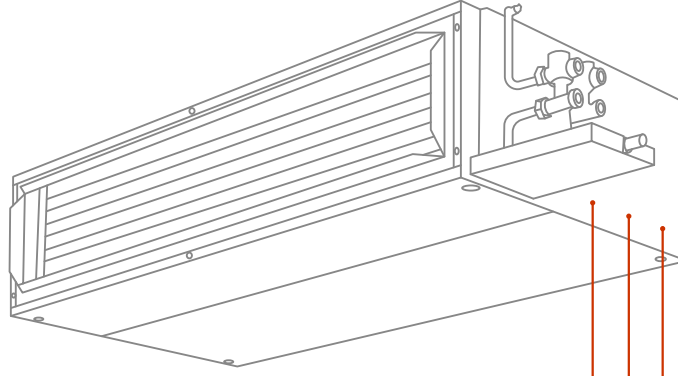

▲ Luna TFT ve ADD-3R-5A FCU Bağlantı Diyagramı

TIS

Copyright © 2020 TIS, All Rights Reserved

TIS Logo is a Registered Trademark of Texas Intelligent System LLC in the United States of America. This company takes TIS Control Ltd. in other countries. All of the Specifications are subject to change without notice.

TEXAS INTELLIGENT SYSTEM LLC

SUITE# 610, 860 NORTH DOROTHY DR
RICHARDSON
TX 75081.USA

TIS CONTROL TÜRKİYE

DEMİRCİKARA MAH. B. ONAT CAD.
1419.SK OCEAN CITY SİTESİ B BLOK
KAT:2 D:3 MURATPAŞA/ANTALYA

TIS LUNA TFT PANEL

4.3" Dokunmatik Panel

Model: LUNA-TFT43

TIS

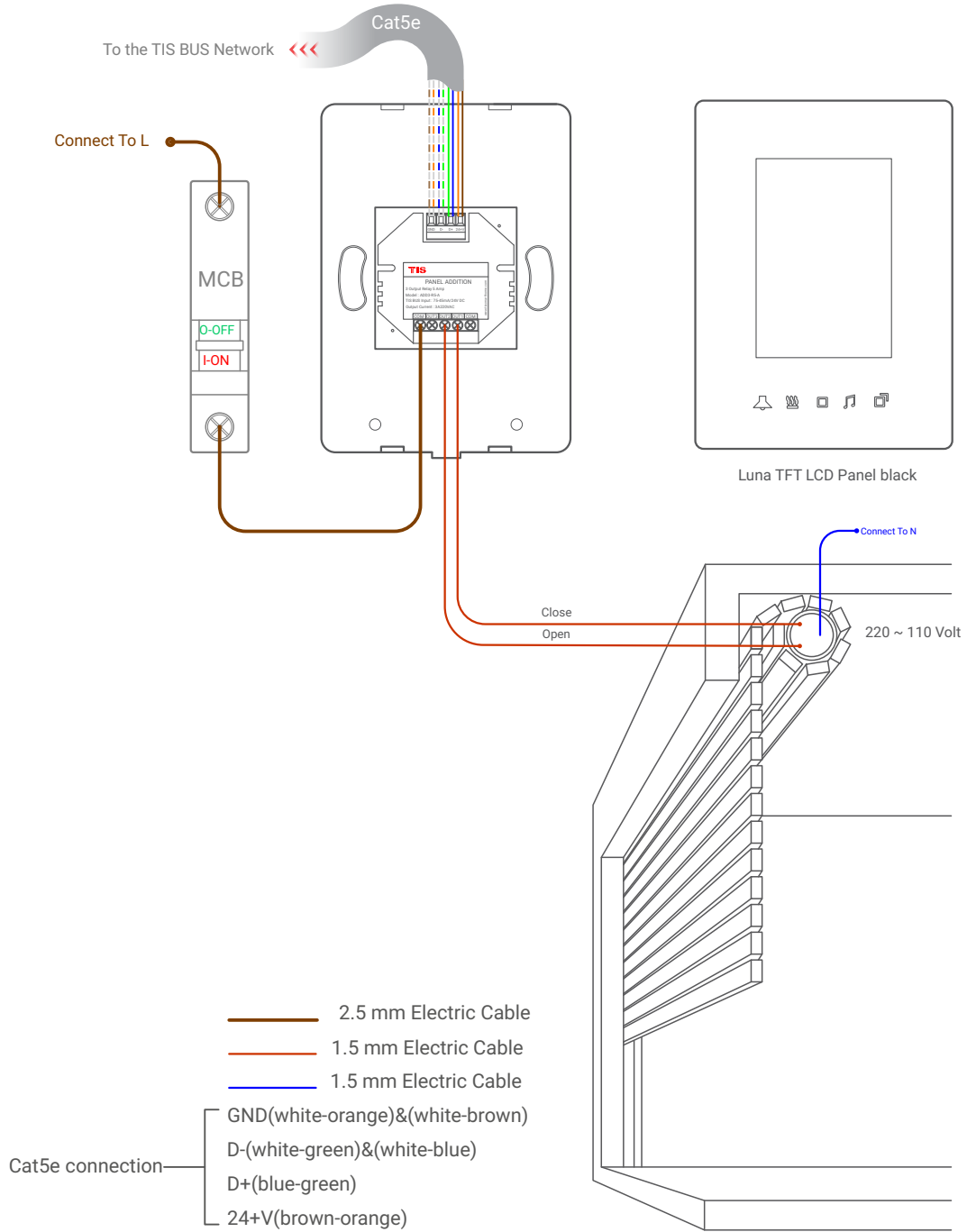

▲ Luna TFT ve ADD-3R-5A Motor Bağlantı Diyagramı

TIS

Copyright © 2020 TIS, All Rights Reserved

TIS Logo is a Registered Trademark of Texas Intelligent System LLC in the United States of America. This company takes TIS Control Ltd. in other countries. All of the Specifications are subject to change without notice.

TEXAS INTELLIGENT SYSTEM LLC

SUITE# 610, 860 NORTH DOROTHY DR
RICHARDSON
TX 75081.USA

TIS CONTROL TÜRKİYE

DEMİRCİKARA MAH. B. ONAT CAD.
1419.SK OCEAN CITY SİTESİ B BLOK
KAT:2 D:3 MURATPAŞA/ANTALYA

TIS LUNA TFT PANEL

4.3" Dokunmatik Panel

Model: LUNA-TFT43

TIS

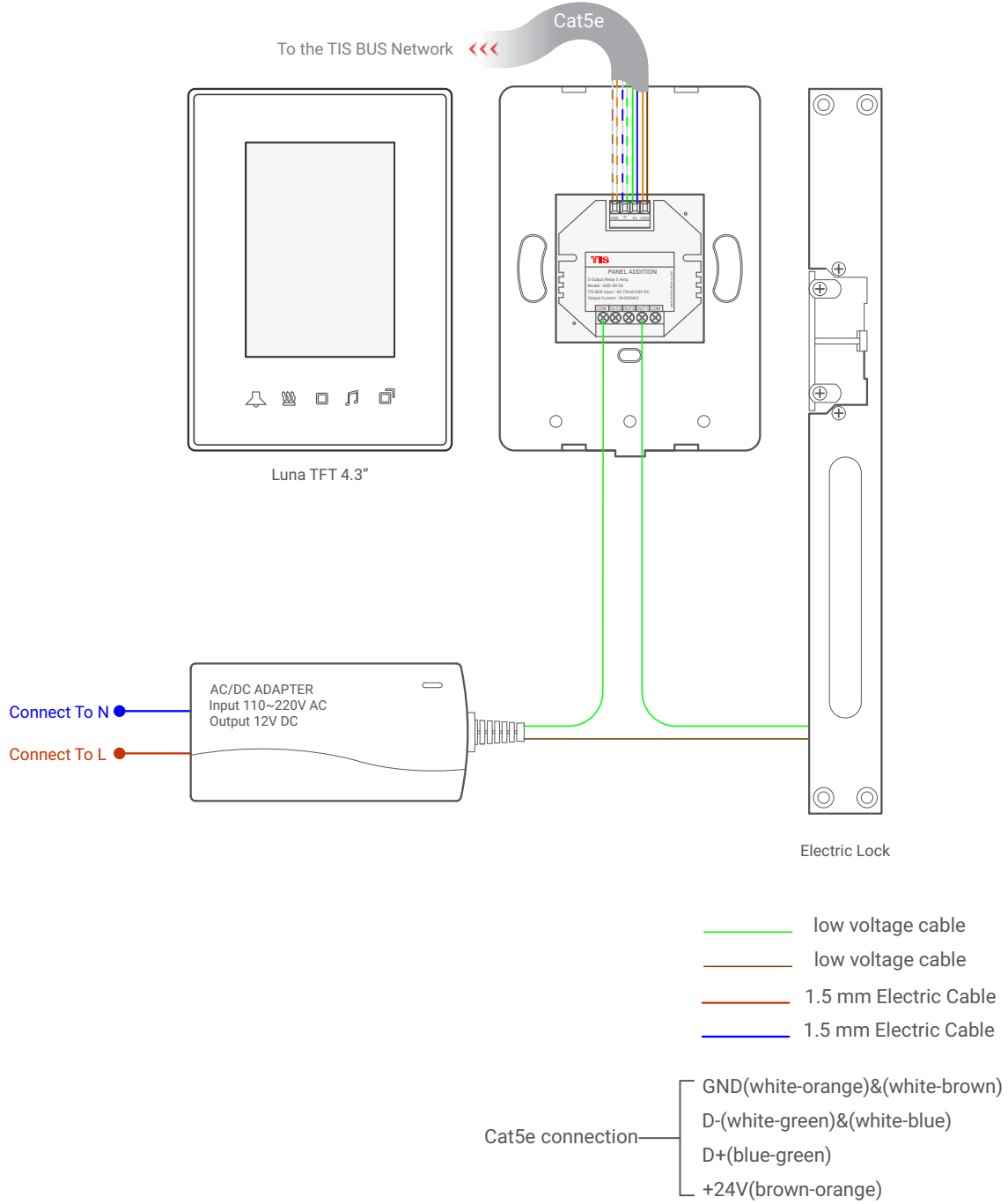

▲ Luna TFT ve ADD-3R-5A Elektrik Kilidi Bağlantı Diyagramı

TIS

Copyright © 2020 TIS, All Rights Reserved
TIS Logo is a Registered Trademark of Texas Intelligent System LLC in the United States of America. This company takes TIS Control Ltd. in other countries. All of the Specifications are subject to change without notice.

TEXAS INTELLIGENT SYSTEM LLC
SUITE# 610. 860 NORTH DOROTHY DR
RICHARDSON
TX 75081.USA

TIS CONTROL TÜRKİYE
DEMİRCİKARA MAH. B. ONAT CAD.
1419.SK OCEAN CITY SİTESİ B BLOK
KAT:2 D:3 MURATPAŞA/ANTALYA

TIS LUNA TFT PANEL

4.3" Dokunmatik Panel

Model: LUNA-TFT43

TIS

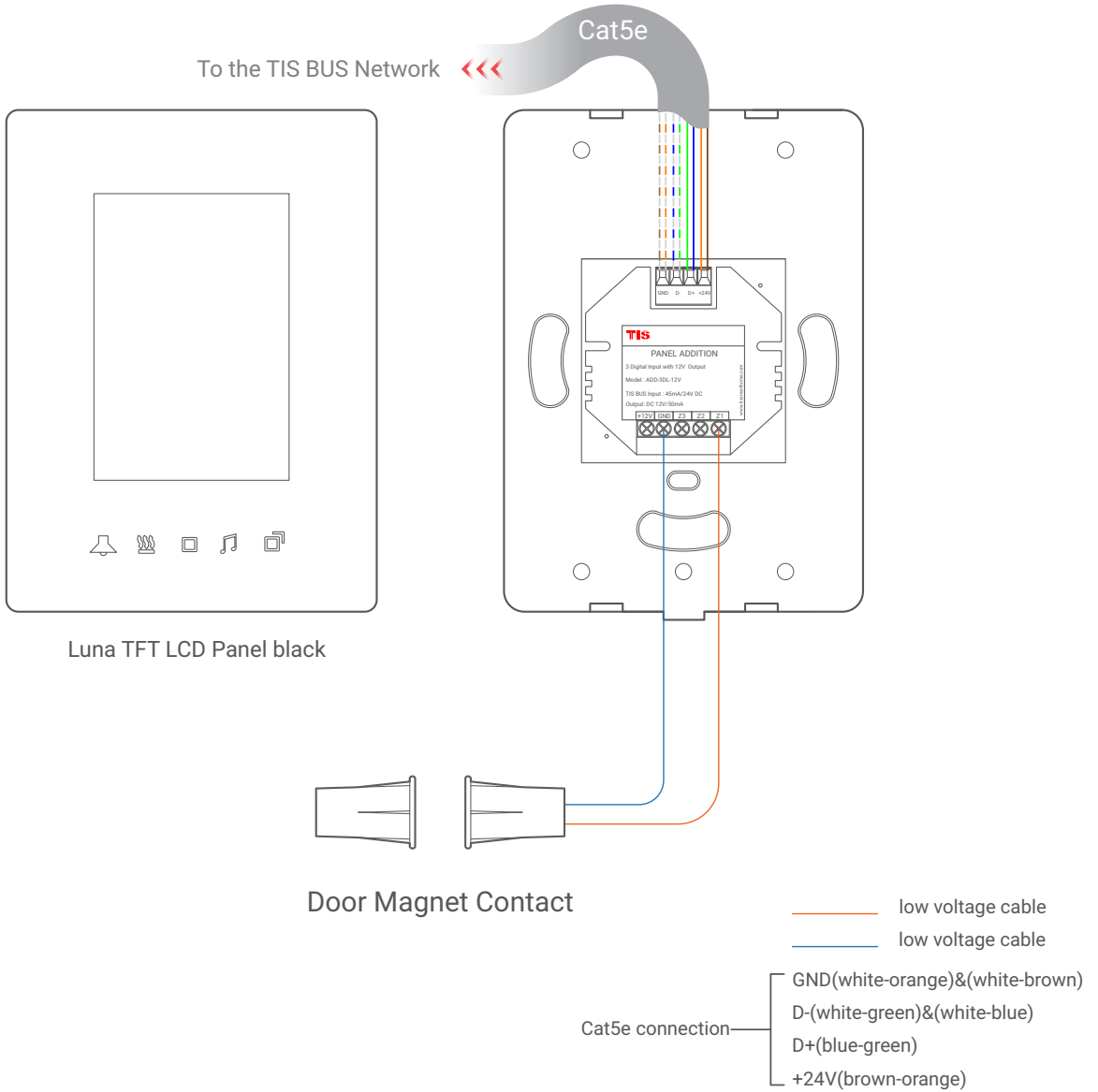

▲ Luna TFT ve ADD-3DL-12V Manyetik Kontak Kapı Bağlantı Diyagramı

TIS

Copyright © 2020 TIS, All Rights Reserved
TIS Logo is a Registered Trademark of Texas Intelligent System LLC in the United States of America. This company takes TIS Control Ltd. in other countries. All of the Specifications are subject to change without notice.

TEXAS INTELLIGENT SYSTEM LLC
SUITE# 610. 860 NORTH DOROTHY DR
RICHARDSON
TX 75081.USA

TIS CONTROL TÜRKİYE
DEMİRCİKARA MAH. B. ONAT CAD.
1419.SK OCEAN CITY SİTESİ B BLOK
KAT:2 D:3 MURATPAŞA/ANTALYA

TIS LUNA TFT PANEL

4.3" Dokunmatik Panel

Model: LUNA-TFT43

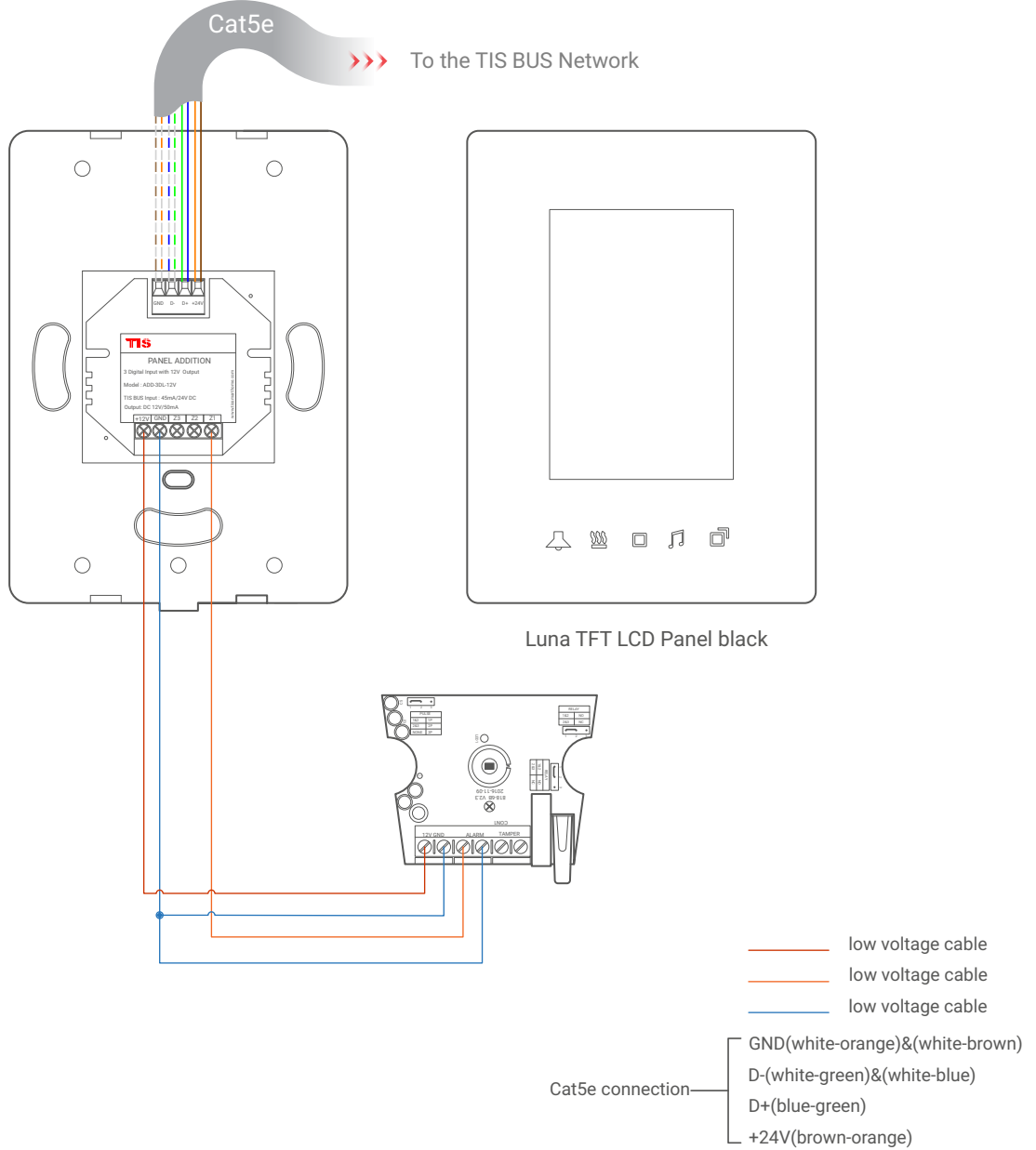

▲ Luna TFT ve ADD-3DL-12V Harici Sensör Bağlantı Diyagramı



Copyright © 2020 TIS, All Rights Reserved
TIS Logo is a Registered Trademark of Texas Intelligent System LLC in the United States of America. This company takes TIS Control Ltd. in other countries. All of the Specifications are subject to change without notice.

TEXAS INTELLIGENT SYSTEM LLC
SUITE# 610, 860 NORTH DOROTHY DR
RICHARDSON
TX 75081.USA

TIS CONTROL TÜRKİYE
DEMİRCİKARA MAH. B. ONAT CAD.
1419.SK OCEAN CITY SİTESİ B BLOK
KAT:2 D:3 MURATPAŞA/ANTALYA

TIS LUNA TFT PANEL

4.3" Dokunmatik Panel

Model: LUNA-TFT43

TIS

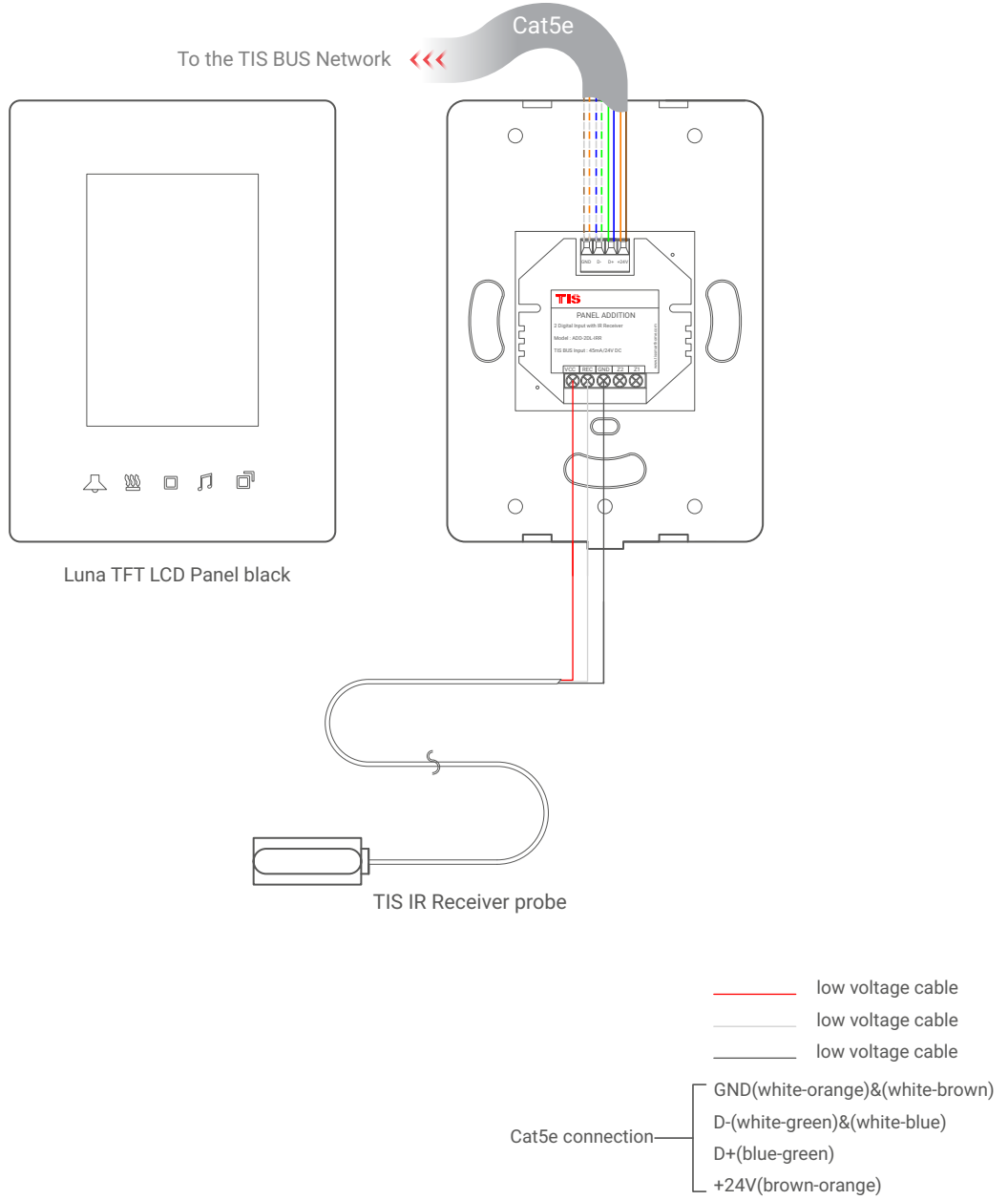

▲ Luna TFT ve ADD-2DL-IRR Alıcı Göz Bağlantı Diyagramı

TIS

Copyright © 2020 TIS, All Rights Reserved
TIS Logo is a Registered Trademark of Texas Intelligent System LLC in the United States of America. This company takes TIS Control Ltd. in other countries. All of the Specifications are subject to change without notice.

TEXAS INTELLIGENT SYSTEM LLC
SUITE# 610, 860 NORTH DOROTHY DR
RICHARDSON
TX 75081,USA

TIS CONTROL TÜRKİYE
DEMİRCİKARA MAH. B. ONAT CAD.
1419.SK OCEAN CITY SİTESİ B BLOK
KAT:2 D:3 MURATPAŞA/ANTALYA

TIS LUNA TFT PANEL

4.3" Dokunmatik Panel

Model: LUNA-TFT43

TIS

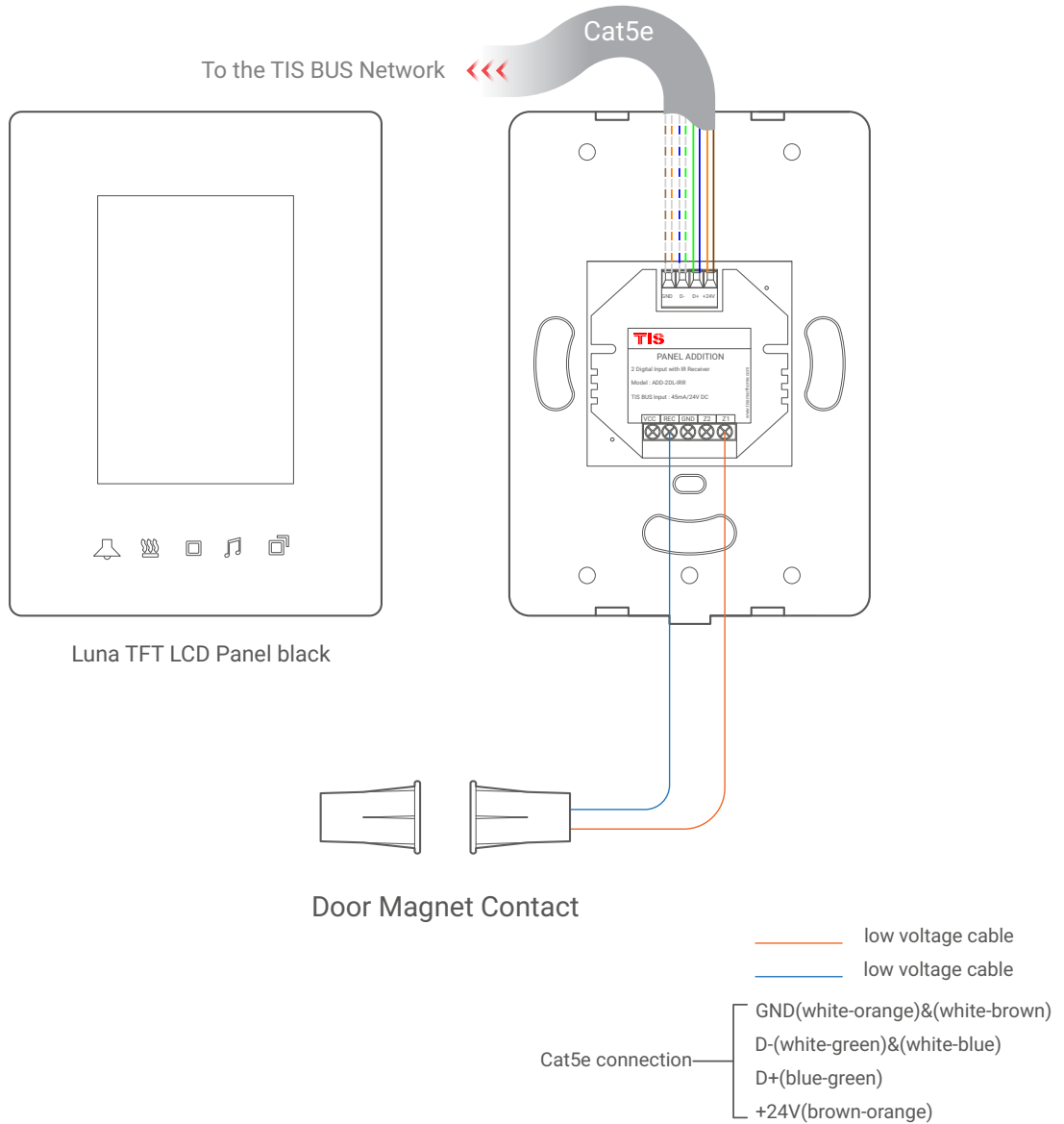

▲ Luna TFT ve ADD-2DL-IRR Alıcı Manyetik Kontak Kapı Bağlantı Diyagramı

TIS

Copyright © 2020 TIS, All Rights Reserved
TIS Logo is a Registered Trademark of Texas Intelligent System LLC in the United States of America. This company takes TIS Control Ltd. in other countries. All of the Specifications are subject to change without notice.

TEXAS INTELLIGENT SYSTEM LLC
SUITE# 610. 860 NORTH DOROTHY DR
RICHARDSON
TX 75081.USA

TIS CONTROL TÜRKİYE
DEMİRCİKARA MAH. B. ONAT CAD.
1419.SK OCEAN CITY SİTESİ B BLOK
KAT:2 D:3 MURATPAŞA/ANTALYA

TIS LUNA TFT PANEL

4.3" Dokunmatik Panel

Model: LUNA-TFT43

TIS

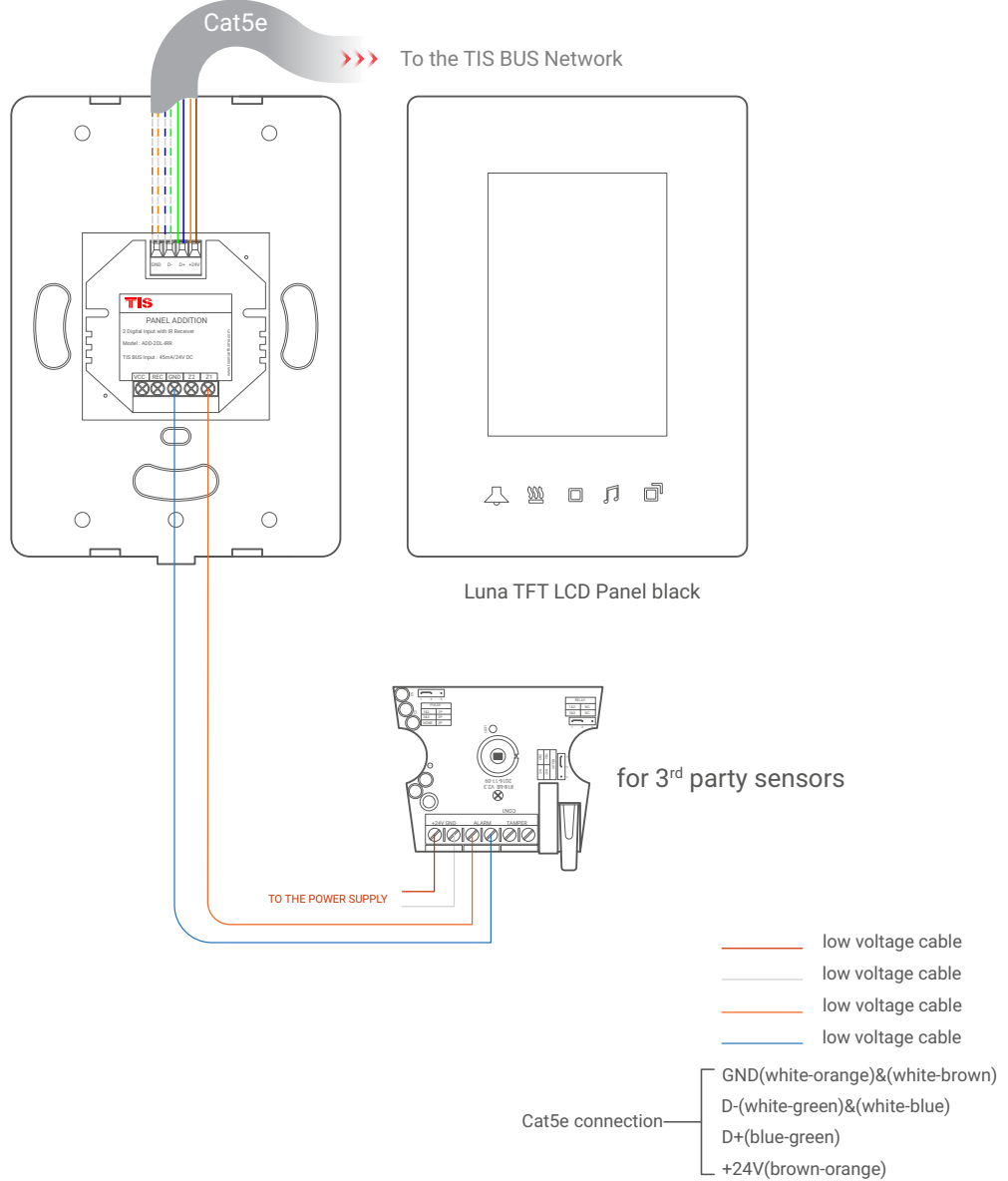

▲ Luna TFT ve ADD-2DL-IRR Alıcı Harici Sensör Bağlantı Diyagramı

TIS

Copyright © 2020 TIS, All Rights Reserved
TIS Logo is a Registered Trademark of Texas Intelligent System LLC in the United States of America. This company takes TIS Control Ltd. in other countries. All of the Specifications are subject to change without notice.

TEXAS INTELLIGENT SYSTEM LLC
SUITE# 610, 860 NORTH DOROTHY DR
RICHARDSON
TX 75081.USA

TIS CONTROL TÜRKİYE
DEMİRCİKARA MAH. B. ONAT CAD.
1419.SK OCEAN CITY SİTESİ B BLOK
KAT:2 D:3 MURATPAŞA/ANTALYA

TIS LUNA TFT PANEL

4.3" Dokunmatik Panel

Model: LUNA-TFT43

TIS

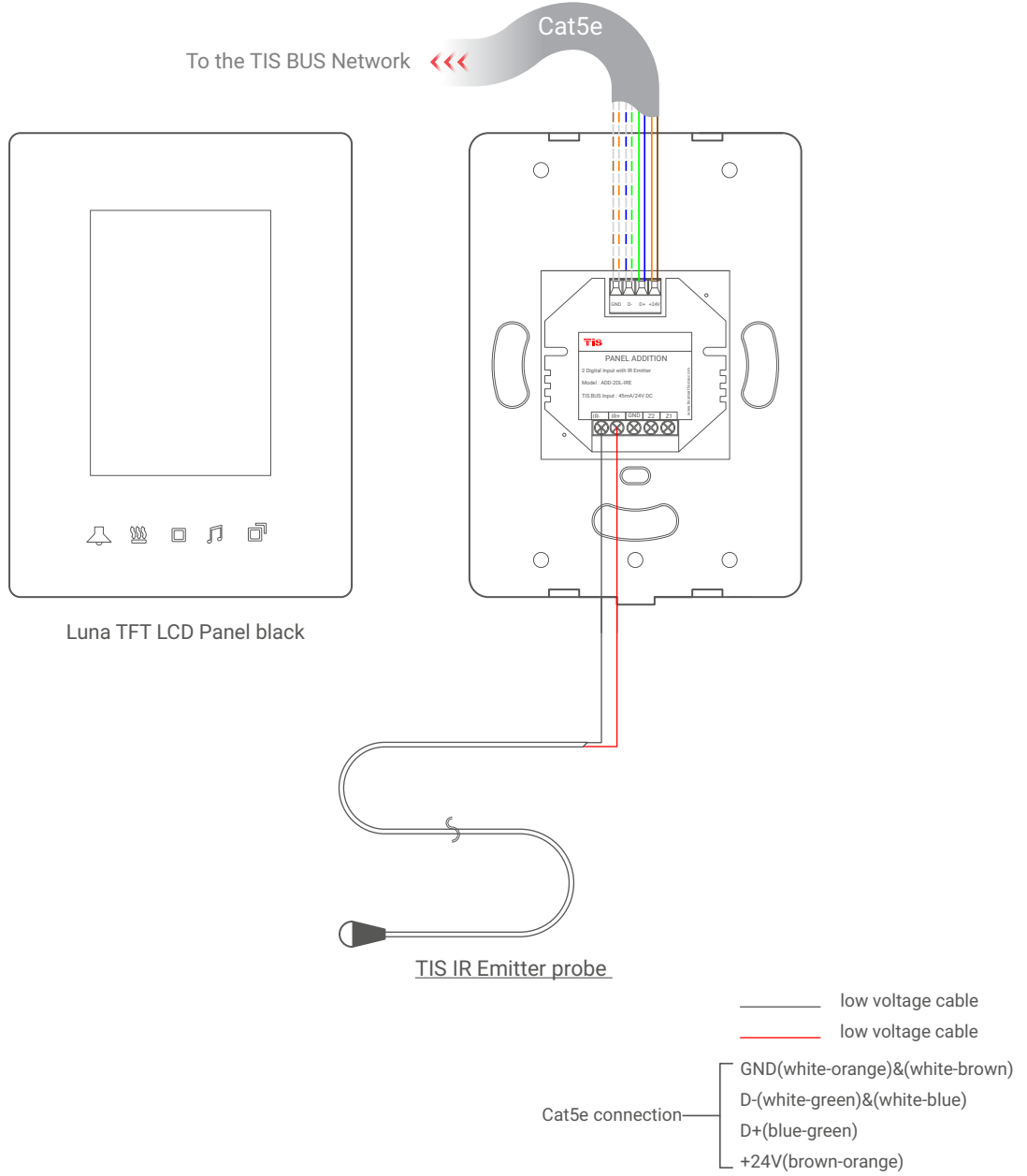

▲ Luna TFT ve ADD-2DL-IRE Verici Göz Bağlantı Diyagramı

TIS

Copyright © 2020 TIS, All Rights Reserved
TIS Logo is a Registered Trademark of Texas Intelligent System LLC in the United States of America. This company takes TIS Control Ltd. in other countries. All of the Specifications are subject to change without notice.

TEXAS INTELLIGENT SYSTEM LLC
SUITE# 610. 860 NORTH DOROTHY DR
RICHARDSON
TX 75081.USA

TIS CONTROL TÜRKİYE
DEMİRCİKARA MAH. B. ONAT CAD.
1419.SK OCEAN CITY SİTESİ B BLOK
KAT:2 D:3 MURATPAŞA/ANTALYA

TIS LUNA TFT PANEL

4.3" Dokunmatik Panel

Model: LUNA-TFT43

TIS

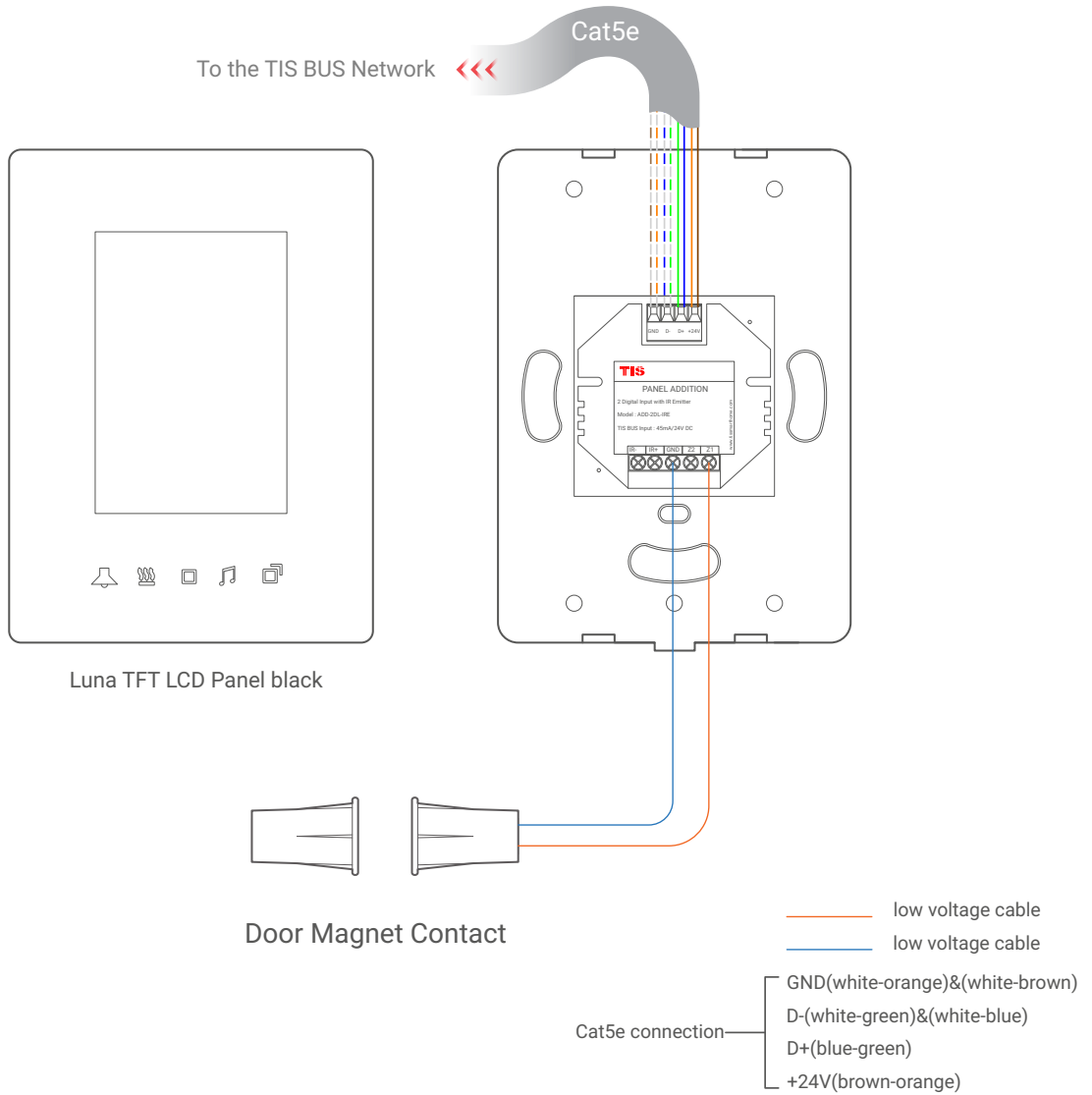

▲ Luna TFT & ADD-2DL-IRE Verici Manyetik Kontak Kapı Bağlantı Diyagramı

TIS

Copyright © 2020 TIS, All Rights Reserved
TIS Logo is a Registered Trademark of Texas Intelligent System LLC in the United States of America. This company takes TIS Control Ltd. in other countries. All of the Specifications are subject to change without notice.

TEXAS INTELLIGENT SYSTEM LLC
SUITE# 610, 860 NORTH DOROTHY DR
RICHARDSON
TX 75081.USA

TIS CONTROL TÜRKİYE
DEMİRCİKARA MAH. B. ONAT CAD.
1419.SK OCEAN CITY SİTESİ B BLOK
KAT:2 D:3 MURATPAŞA/ANTALYA

TIS LUNA TFT PANEL

4.3" Dokunmatik Panel

Model: LUNA-TFT43

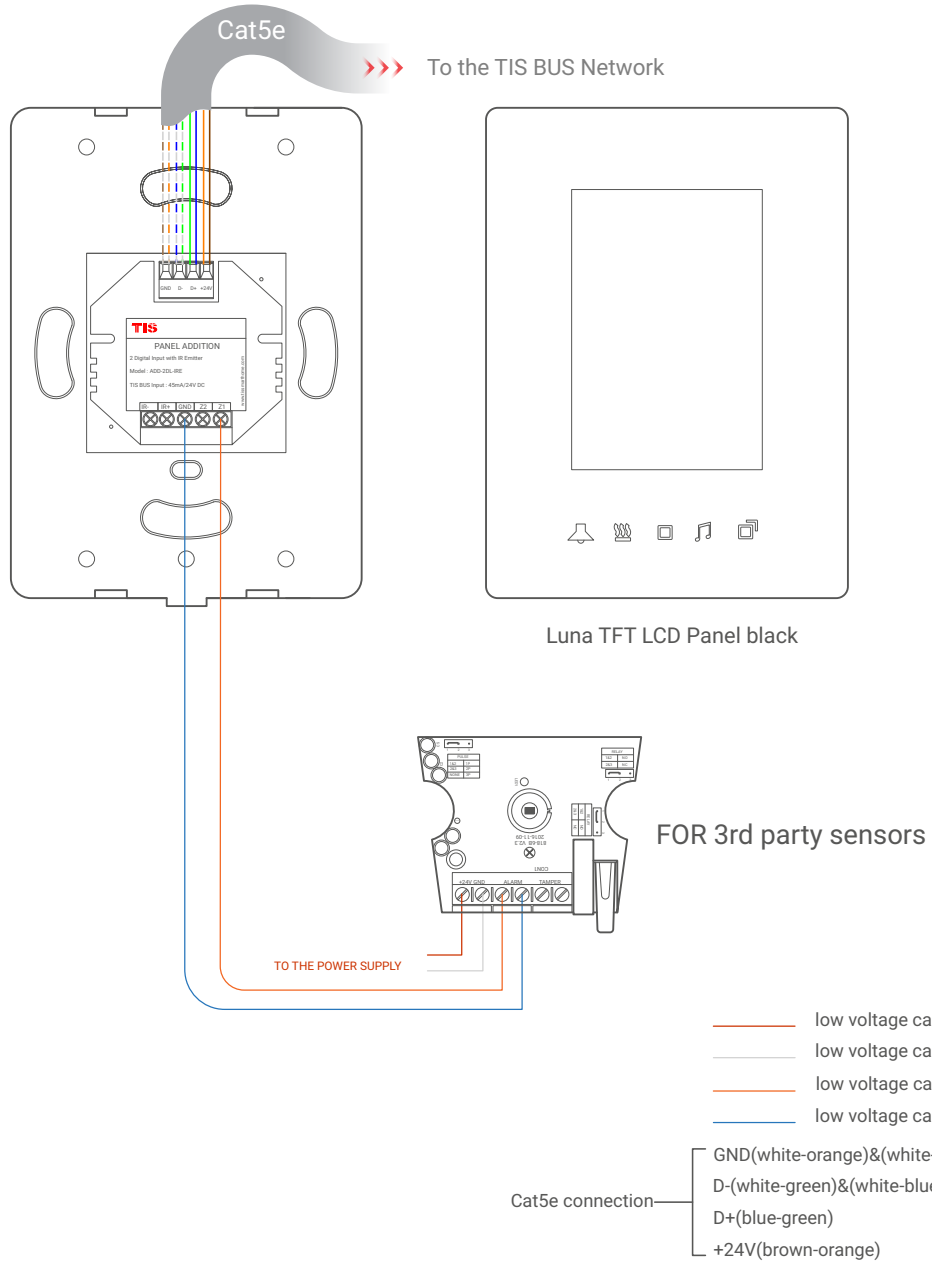

▲ Luna TFT ve ADD-2DL-IRE Verici Harici Sensör Bağlantı Diyagramı



Copyright © 2020 TIS, All Rights Reserved
TIS Logo is a Registered Trademark of Texas Intelligent System LLC in the United States of America. This company takes TIS Control Ltd. in other countries. All of the Specifications are subject to change without notice.

TEXAS INTELLIGENT SYSTEM LLC
SUITE# 610, 860 NORTH DOROTHY DR
RICHARDSON
TX 75081.USA

TIS CONTROL TÜRKİYE
DEMIRCIKARA MAH. B. ONAT CAD.
1419.SK OCEAN CITY SITESİ B BLOK
KAT:2 D:3 MURATPASA/ANTALYA

TIS LUNA TFT PANEL

4.3" Dokunmatik Panel

Model: LUNA-TFT43

TIS

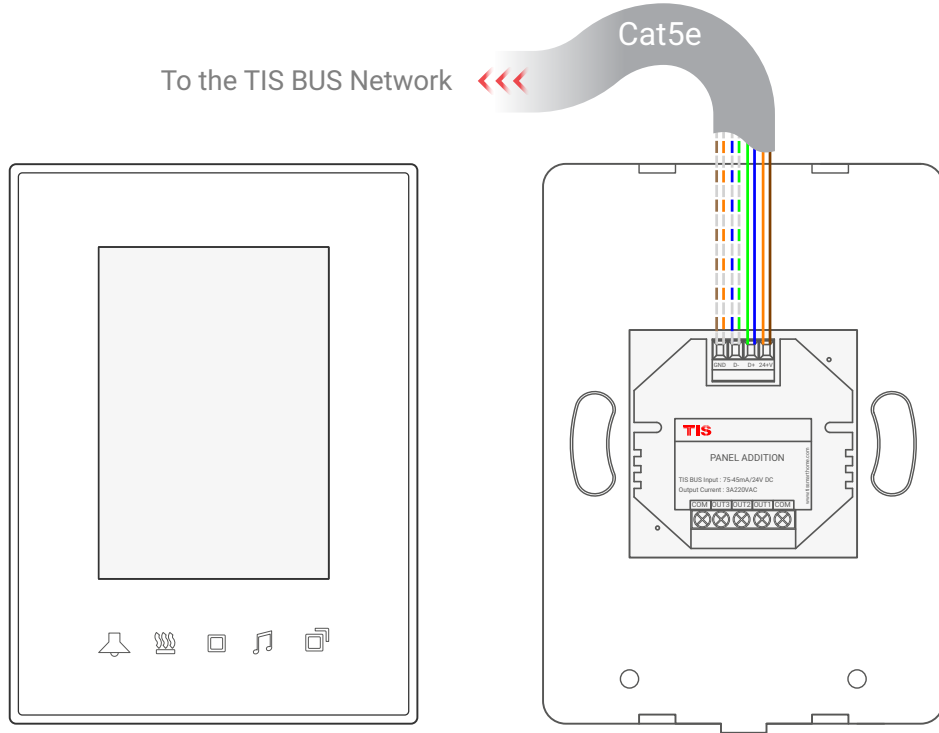

Luna TFT 4.3"

Cat5e connection — GND(white-orange)&(white-brown)
D-(white-green)&(white-blue)
D+(blue-green)
+24V(brown-orange)

▲ Luna TFT Bus Bağlantı Renk Kodları

TIS

Copyright © 2020 TIS, All Rights Reserved

TIS Logo is a Registered Trademark of Texas Intelligent System LLC in the United States of America. This company takes TIS Control Ltd. in other countries. All of the Specifications are subject to change without notice.

TEXAS INTELLIGENT SYSTEM LLC

SUITE# 610, 860 NORTH DOROTHY DR
RICHARDSON
TX 75081,USA

TIS CONTROL TÜRKİYE

DEMİRCİKARA MAH. B. ONAT CAD.
1419.SK OCEAN CITY SİTESİ B BLOK
KAT:2 D:3 MURATPAŞA/ANTALYA

TIS LUNA TFT PANEL

4.3" Dokunmatik Panel

Model: LUNA-TFT43

TIS

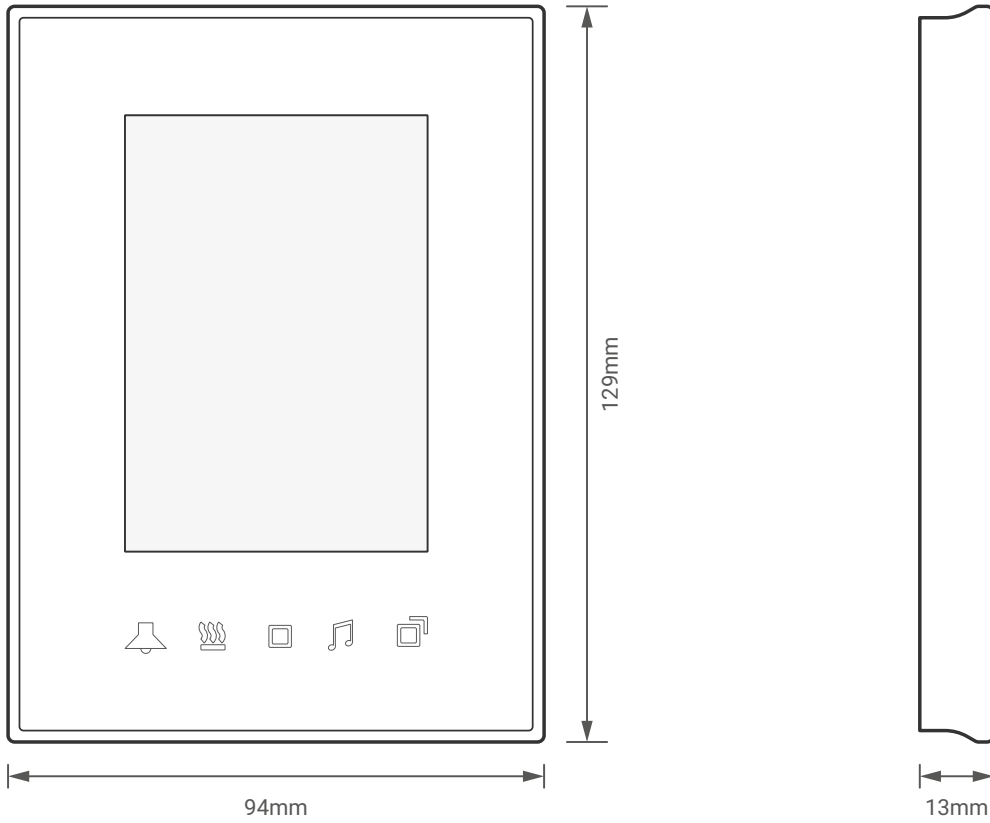

▲ Modül Boyutları

TIS

Copyright © 2020 TIS, All Rights Reserved
TIS Logo is a Registered Trademark of Texas Intelligent System LLC in the United States of America. This company takes TIS Control Ltd. in other countries. All of the Specifications are subject to change without notice.

TEXAS INTELLIGENT SYSTEM LLC
SUITE# 610. 860 NORTH DOROTHY DR
RICHARDSON
TX 75081.USA

TIS CONTROL TÜRKİYE
DEMİRCİKARA MAH. B. ONAT CAD.
1419.SK OCEAN CITY SİTESİ B BLOK
KAT:2 D:3 MURATPAŞA/ANTALYA