

ADS | Universal Dimmer

Installation and programming manual

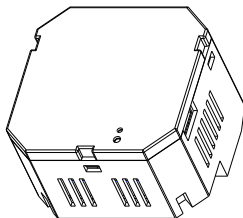

 TISAIR

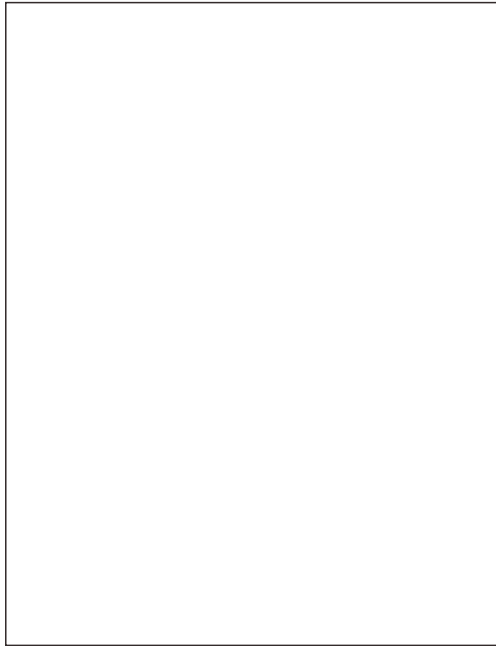

ADS Wiring Diagram

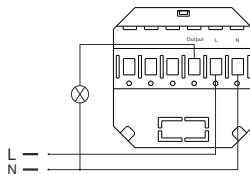

ADS | Universal Dimmer

ADS-1D-1Z

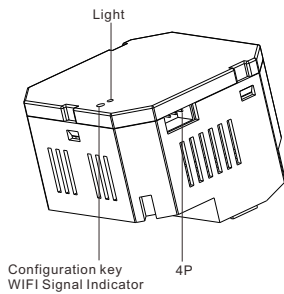

Installation Steps

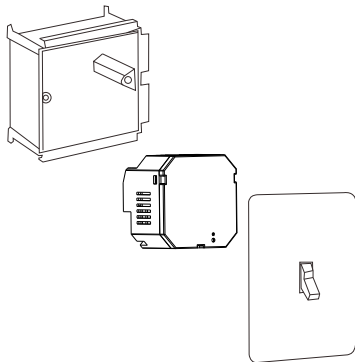

Warning

You should configure the panel outputs in the correct mode before using it, as lights, curtain or air conditions from your application setting

Operation Instruction

Download and install APP



Android



IOS

Open the APP interface and click the Settings icon

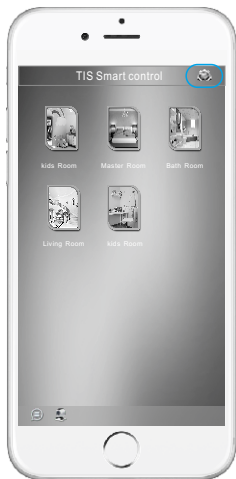

Enter the administrator account and password,
default username: user
default password: tis777



Enter the settings interface, select "TIS AIR CONFIG".



Power the smart switch, press the Configuration
TIS key for 5 second till it starts blinking

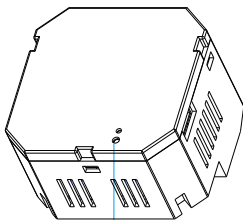

Configuration key
WIFI Signal Indicator

Enter your WiFi router password then click "SEARCH", the device will be configured within 50 seconds

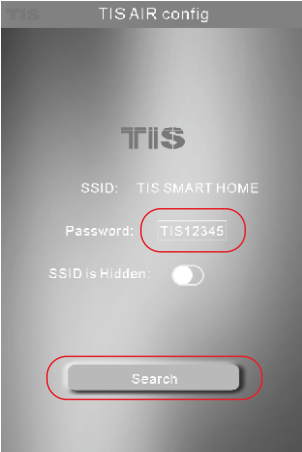

The image shows a mobile application interface for configuring a TIS AIR device. The screen has a dark grey background with white text. At the top, the text "TIS AIR config" is displayed. Below this is the TIS logo. The configuration options are as follows:

- SSID: TIS SMART HOME
- Password: TIS12345 (The password field is highlighted with a red rounded rectangle)
- SSID Is Hidden: A toggle switch that is currently turned off.

At the bottom of the screen, there is a large, rounded rectangular button labeled "Search" (The button is highlighted with a red rounded rectangle).

Configuration key will be turned to blue once it successfully configured, and the following page will be shown. click on "GO TO MODIFY "

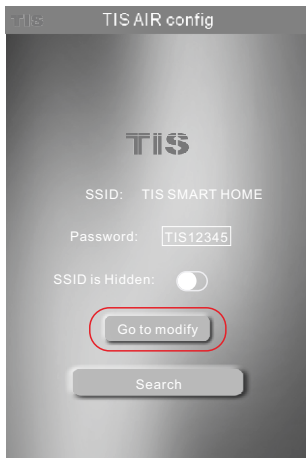

Enter your panel setting

Device comment: any comment like panel location, it helps programmer in advanced search and settings in Device Search software.

Net id & Device ID:

Enter unique Subnet ID and Device ID for your panel.

MAC ADDRESS:

Each device has its MAC address to use it later in Network Setting to be able to link your mobile to the device and internet remote control setting.

New ADD button function

when you saved the panel to new address it is important to link its touch buttons to control the panel relays new address.

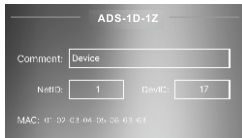

ADS-1D-1Z

Comment:

NetID: DevID:

MAC: 01 02 03 04 05 06 07 08

Select Room: press on the select room icon and select the location of where you had installed your panel, if the room is not exist, you can add it from the main setting page.

Channel Icons: press on the channel icon and select the icon from the default library or from your own gallery or just take new picture from your phone.

Channel comment: type the name of your lighting channel.

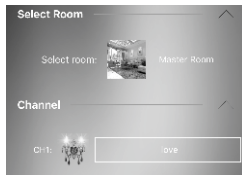

Blackout Setting

you can set the panel to its last status when powered on or set it to turn on or turn off

Server Info:

you can use one device in each project as master gateway for server internet connection.

Warning: just enable the nearest device to your router as master device for internet connection

Enter your own 4 digit password.

Keep the default setting of TIS

Server address as 120.24.42.209, or modify it with other TIS server depends on your country location.

The screenshot shows a mobile application interface with two main sections. The top section, titled "Black Out Setting", has a toggle for "Return to last Status Upon Powered ON" which is checked. Below it, there are two radio buttons for "Return to the specified value": "0%" (selected) and "100%". The bottom section, titled "Server INFO", has a toggle for "Use This Device as Master internet Gateway" which is checked. Below this are input fields for "Password:" (masked with four asterisks), "Server IP:" (with the value "120.24.42.209" and a "bc it" button), and a "WARNING:" message at the bottom.

Control Section

select your room and start control
your lights, AC , curtain and others



Warranty Card

From the date of purchase, 1 year limited warranty.

Damage caused by wrong installation , physical damaged , users dismantle repair and other man-made damage will be out of warranty

| | |
|------------------|--|
| User name | |
| Phone number | |
| Address | |
| Official Dealer | |
| Product SN | |
| Purchase date | |
| Repairing record | |