



# TISAIR

Wireless Automation Product



[www.tissmarthome.com](http://www.tissmarthome.com)



## TIS

Automation made easy



Automation Made Easy

2017

## Index

Smart Panels

[P07](#)

Door Phone System

[P23](#)

AIR Controller

[P31](#)

Applications

[P47](#)



# TISAIR

Automation made easy by TIS AIR system, just install it quickly, configure it and control. Turn on your lights, air condition and manage your connected appliances from your smart phone. TIS-AIR works with standard WIFI 2.4 Ghz , it is easy to connect directly to your WIFI router and control it locally or remotely anywhere. Also TIS-AIR is fully compatible with TIS-BUS Products making your automation solution unlimited.

TIS AIR is an expandable automation system with unlimited devices which can be connected wirelessly or combined with wired. As installation and programming time measured is in hours, and the needless for rewiring, the TIS AIR system is your ideal automation solution.

Our TIS AIR product range is constantly expanding to be the leading wireless automation system in the world. Currently TIS AIR range covers: touch panels, switches, dimmers, plug sockets, LED driver, power sockets, sensors, Infrared controller, video door phone, camera, and Air-Bus convertor to use any bus available devices as WIFI such as music, energy meter and others.

# MY HOME IS SMART HOME

## Simple to Program

TIS-AIR has made the automation easy to anyone.  
Now you can take complete control over your home or office without any prior programming experience.  
What you can control and monitor simply.

# Do It Yourself

## Easy to install

Installing TIS AIR system doesn't require any rewiring or renovation. As Example simply remove your old lights switch, and replace it by TIS WIFI panel connecting it to the existing wiring (L/N). As the system communicates by WIFI, easily you can configure it from your smart phone,





## Direct Link

No need for any extra gateway, TIS AIR Panels and other AIR items can connect to internet, and you can control it from anywhere, all you need is to install it and link it to your wifi router at home or office.

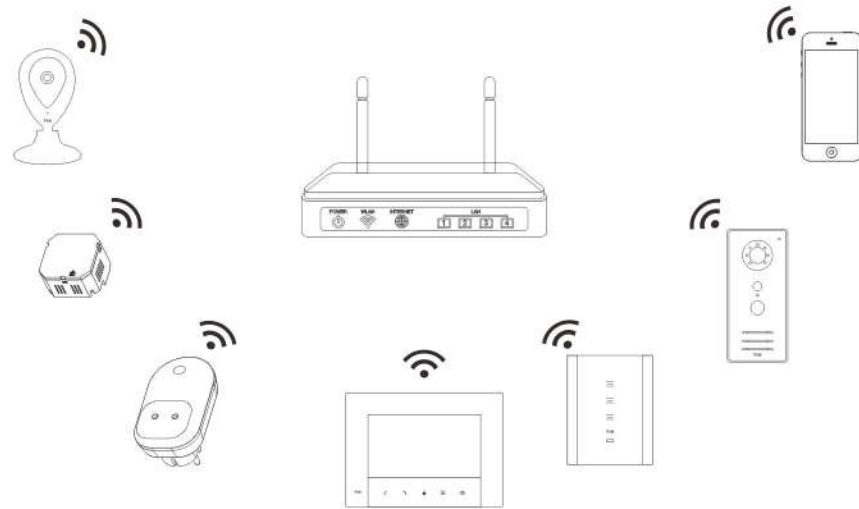

## Range

To enhance the range of TIS-AIR, all devices WIFI antenna position is placed in front of each device. The wifi 802.11a standard can support the range of 115 ft (35 met) indoor. However, keep in mind that calculating attenuation and wireless ranges indoors can be very tricky. That's because inside your house, the Wi-Fi signal bounces off obstacles and has to penetrate a variety of materials (like walls) that weaken the signal.

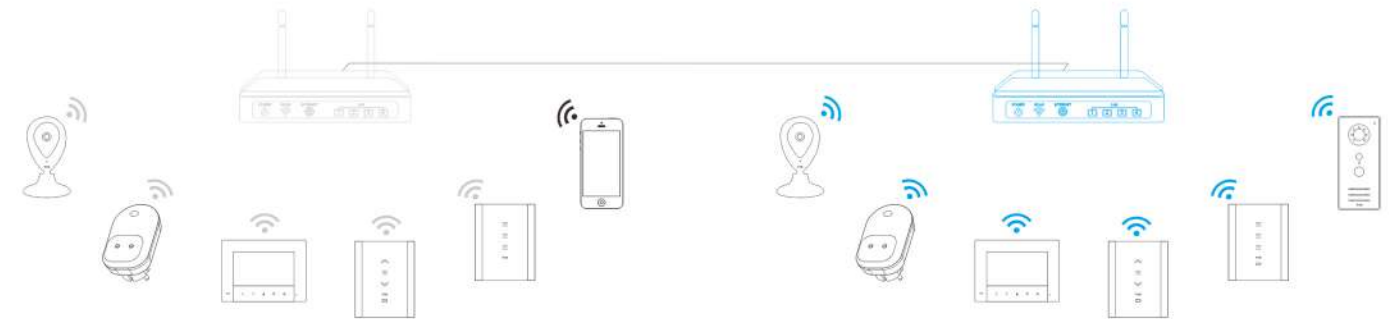

## Extendable

If you have a big house, with many floors, You can use a wired Wi-Fi extender to extend the wireless network into a far corner of the home. In essence, they carry the wireless signals through a wired connection (where there's less attenuation and interference) and then send out a strong wireless signal in the new location.

# Smart Panels



VENERA

LUNA  
SERIES

MARS  
SERIES

TERRE

## Venera Series

With its elegance glass stylish design, Venera Series panels gives you control capabilities of capacitive pads to switch lights ON/OFF, dim it or control your air conditioning system.

Venera Series brings intuitive control over a single room, or an entire building with its programmable ability and DIY feature. Program your RGB LED indication levels, with Built-in IR receiver and direct server connectivity without gateway, you can control it locally or remotely from anywhere.

Support all EU, UK, and US standard junction box size.

Available in black or white color (customized color and design can be done)

Dimensions: 85x109x42.3mm



# Venera Switch



Venera ON/OFF Lighting panels available in 2-3 button combinations, it can control its relay channels, also you can set it to control scenes by sending commands to other devices in TIS system.

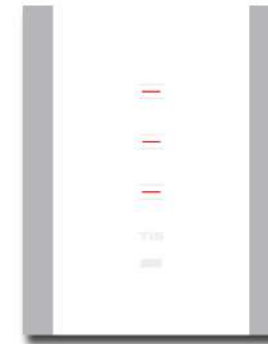

Model Number	VEN-3S-3R-HC	VEN-2S-2R-HC	VEN-xS-yR-HC	VEN-3S-3R-BUS
Working voltage	AC85-230V 50/60Hz	AC85-230V 50/60Hz	AC85-230V 50/60Hz	DC 12-32V
Output channel	3CH relay	2CH relay	yCH relay (y=1-3)	3CH relay
Input connection	Line & Neutral connection	Line & Neutral connection	Line & Neutral connection	Cat5E bus cable
Output current	8A 250VAC per CH	8A 250VAC per CH	8A 250VAC per CH	8A 250VAC per CH
Control buttons	3 button	2button	x button (x=1-3)	3 button
TIS AIR Module	Yes	Yes	Yes	NO

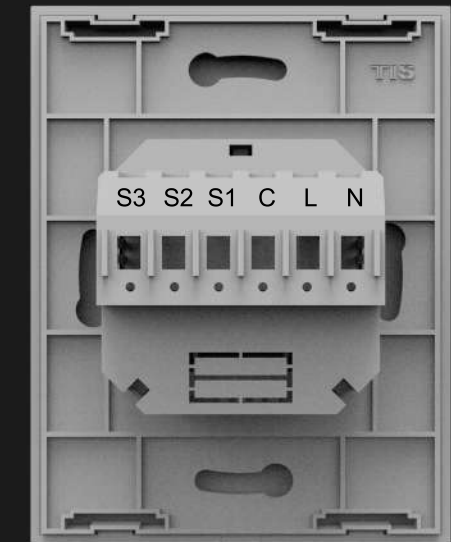



# Venera Dimmer

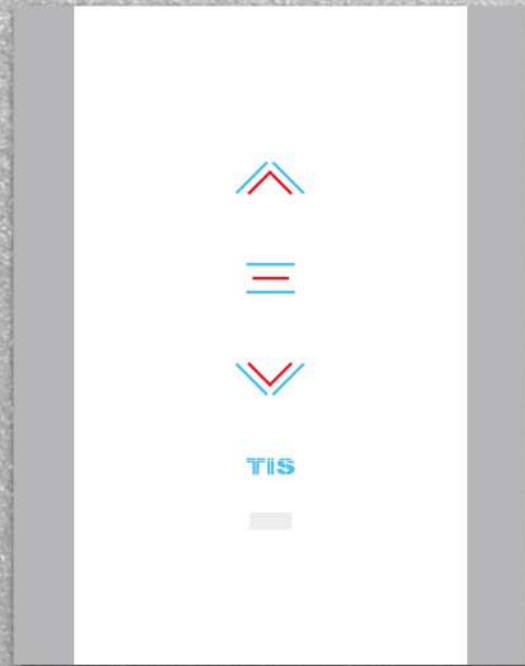
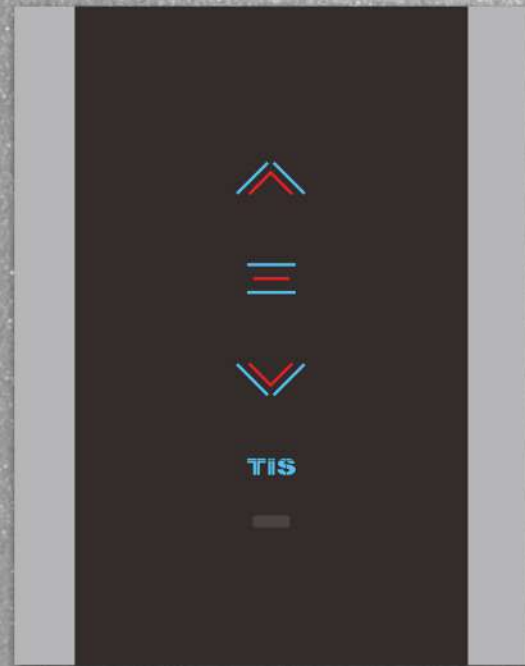

VENERA Universal Dimmer  
It is 1 channel dimmer controlled by 3 buttons as ON/OFF, Ramp up and Dim Down.  
Use both a line, and a neutral connection to power on the Venera panel.  
Capable of MOSFET dimming and switching where as it can dim most of loads type.

Working voltage:AC85-230V50/60Hz  
Output:1channel channel  
Output current:Channel Load  $\leq$  1.5A

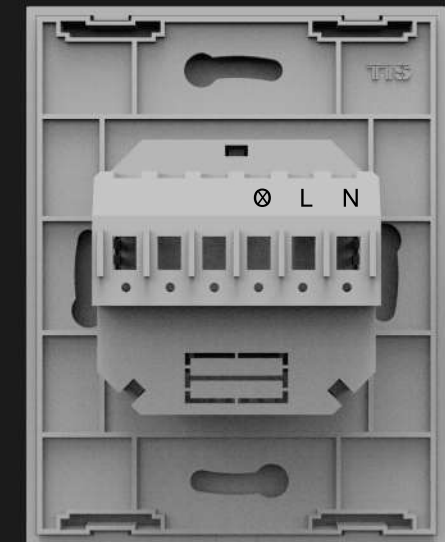

VEN-1D-UV



# Venera Thermostat



The VENERA AC Panel designed to be very simple to control your Air condition.  
 Using four standard buttons, with integrated 1" OLED display.  
 To adjust the temperature simply press up/down button to enables the desired setting temperature level.

Ensuring that your desired temperature level is achieved, the Panel integrated thermal sensor is able to both display the current, as well as maintain the room setting temperature. With Venera AC you can control both Floor heater and FCU unite.  
 Also can be programmed to control split AC or VRV AC.



Model Number	VEN-AC-3R-HC	VEN-AC-5R-LC	VEN-AC-4R-HC
Working voltage	AC85-230V 50/60Hz	DC 12-32V	AC85-230V 50/60Hz
Output channel	3CH relay	5CH relay	4 CH relay
Input connection	Line & Neutral connection	FCU 7 wires connection	Line & Neutral connection
Output current	8A 250VAC per CH	1A 24VDC per CH	3A 250VAC per CH
TIS AIR Module	Yes	Yes	Yes





Luna Panel series which is available in 3 product ranges and available in Black or White, Available as a 9 Button touch panel interface, Bedside panel with climate control thermostat or the top of the executive Luna TFT with audio, climate and customisable multipage interface with Security Arming moods features.

Panel with 4.3" touch screen and LCD, Temperature sensor , offers a stylish and sophisticated interface for managing lighting, music, climate, motors, security, moods and other third party devices, will also display reminders and alerts via the high resolution screen.



Luna TFT LCD Panel

This series is available in two colours, Black or White as well as any customised colour that can suit any style. Our Luna interfaces are coupled with AIR BUS Convertor to be linked to TIS AIR

Luna series designed to fit in any back box (Australia, UK, Europe and US standard).

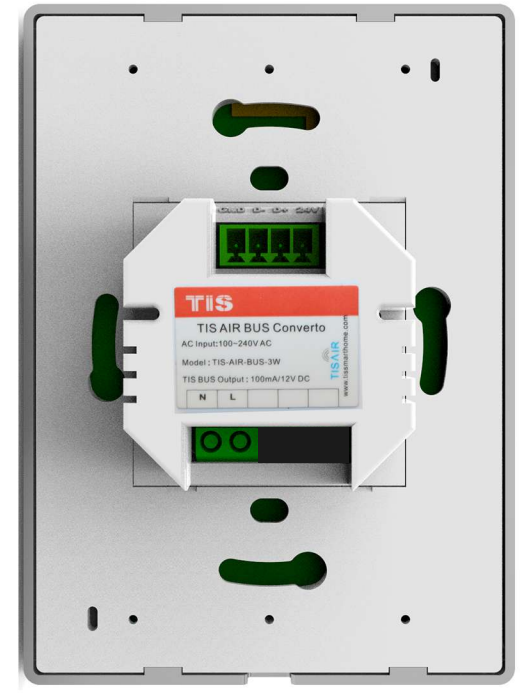



Luna bed side

Panel with 4.3" touch area , 12 buttons, Temperature sensor , and 1" OLED screen, offers a stylish interface for managing climate, lighting, moods in simple way for any guest.

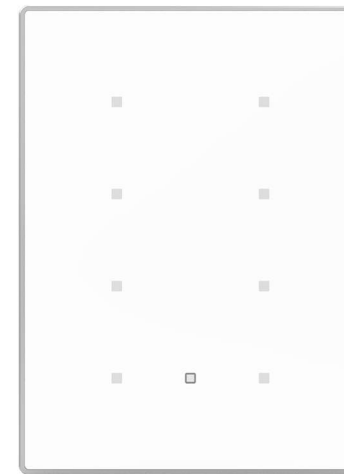
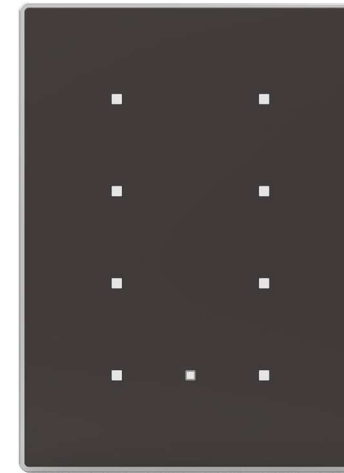

Luna 9G

Panel with 4.3" touch area and 9 buttons offers a stylish interface for managing lighting, motors, moods and other third party devices.

This series is available in two colours, Black or White as well as any customised colour that can suit any style. Our Luna interfaces are coupled with AIR BUS Converter to be linked to TIS AIR

Luna series designed to fit in any back box (Australia, UK, Europe and US standard).

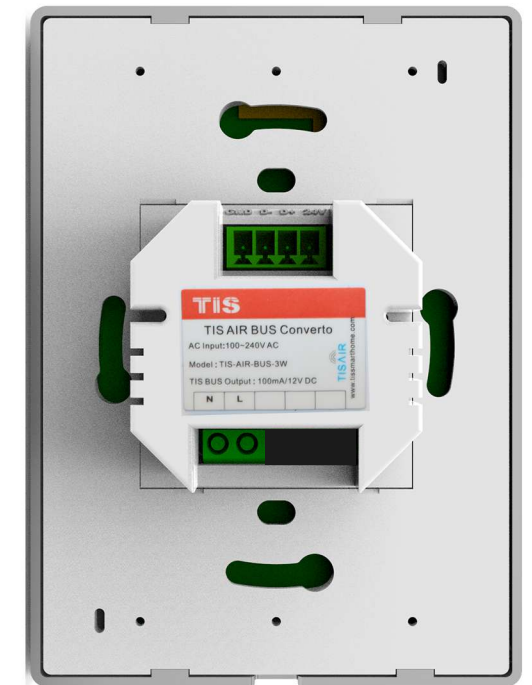





MARS Panel Series which are available in 3 product ranges and 7 different colour to suit your colour scheme. This includes the executive line which has audio, climate and lighting control capabilities all in one panel.



Mars 10 Gang+AC  
With 10+2 buttons and 1" OLED highresolution screen, built in temperature sensor, offers a stylish interface for managing lighting, climate, motors, moods and music , will also display reminders



With 8 or 4 Button, 2 colour LED for each button, this panel has built in IR receiving functionality which can receive signals from the TIS-MRC handheld remote control managing lighting, motors, moods..

Available in Jet Black, Seashell White, Antique Bronze, Champagne, Natural Coal, Titanium, Pale Silver and Customized colour that can suit any style.

Our Mars interfaces are coupled with AIR BUS Convertor to be linked to TIS AIR

Mars series designed to fit in any back box (Australia, UK, Europe and US standard).

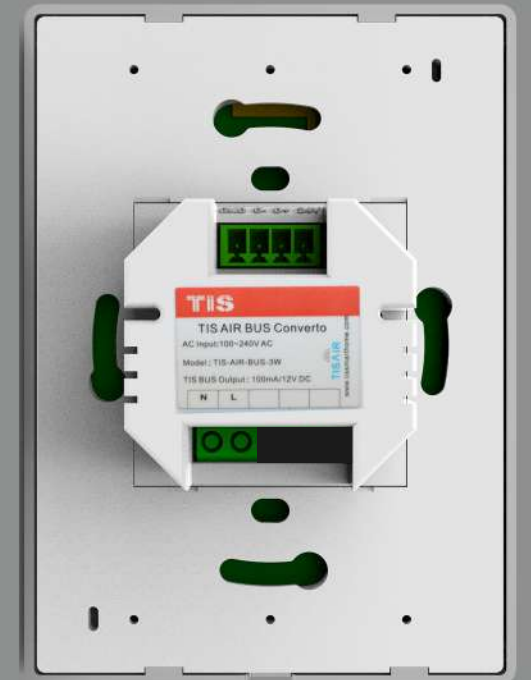

# TERRE

Terre Series Include wall panels and sockets, available with glass, Plastic, wood, leather, stone or metal finishes, Available as a 4 Button touch panel interface, thermostat touch panel, Music touch panel, 1 gang switch, 2 gang switch, Bell switch, and with many sockets include, EU Power socket Universal Power socket, USB Charger, Speaker connector, Telephone, TV Male/Female, Data, LED indicator and blank plate socket. Terre

panel is designed to fit in (UK, and Europe box size standard).



## Terre 4 Gang touch panel

Simple 4 touch button with backlight to control your room lights curtain and moods.

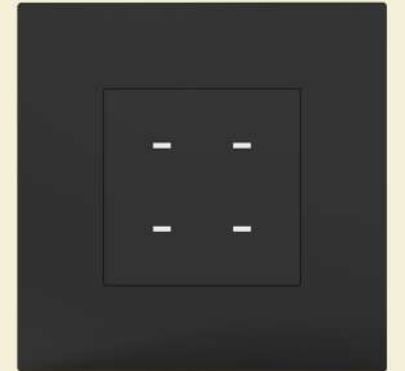

## Terre Air condition control Panel

Control your room temperature by touch buttons, by controlling your fan speed, floor heater or Split Air condition, will also display reminders and alerts via the high resolution OLED 1" screen.



## Terre Music Control Panel

Display your music track and control your TIS Audio player from the user friendly Terre interface panel. will also display reminders and alerts via the high resolution OLED 1" screen.







## DOOR PHONE SYSTEM

Oberon is an IP based digital video door phone system, with its server connection function you can answer your door anywhere, open the door and monitor it anytime.

The oberon contain many devices such as indoor touch screen unite and outdoor calling centers.

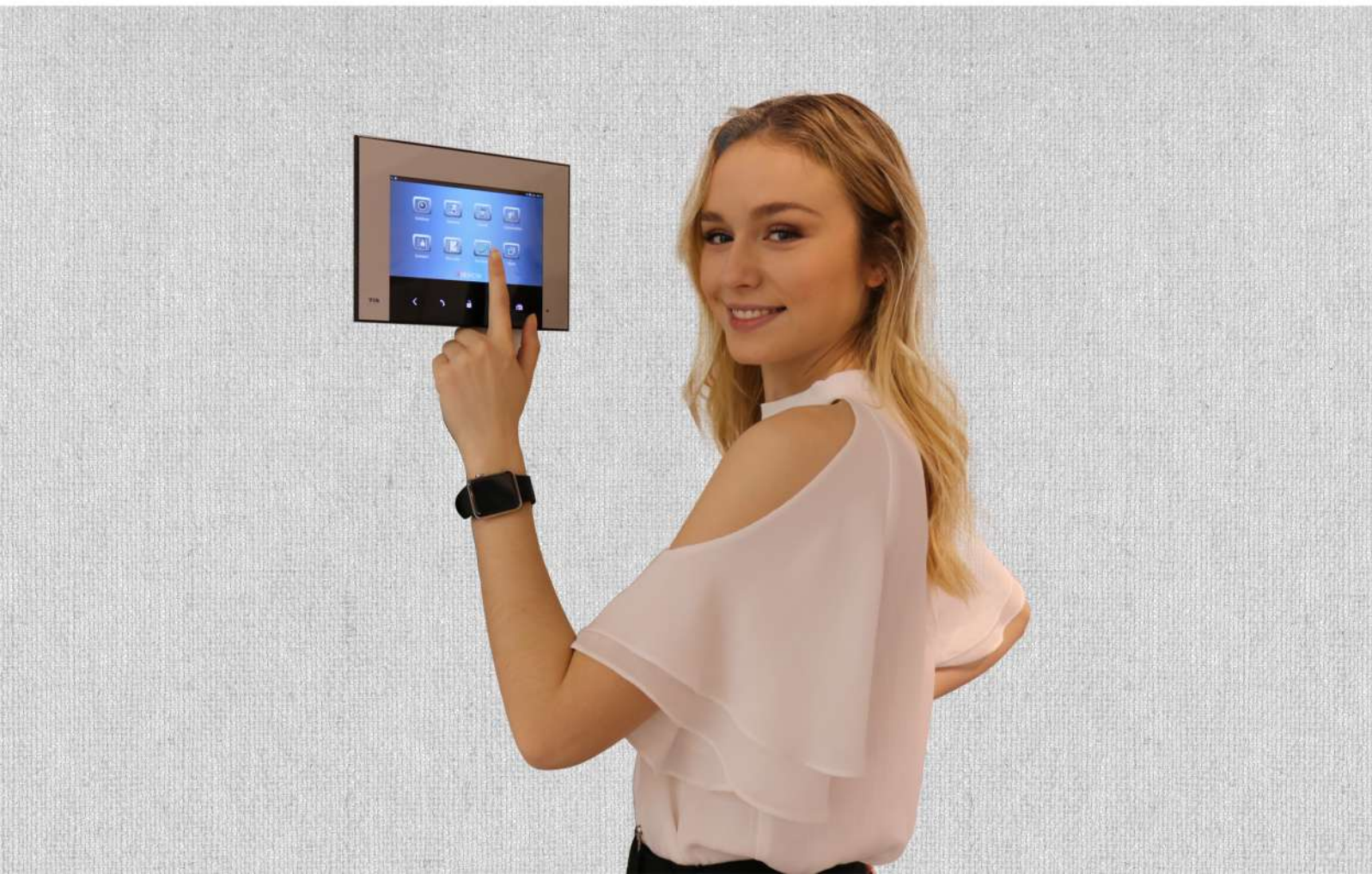

### Indoor 7" Touch Screen

Answer your door, monitor your cameras, call another neighbor unit, call the security guard and control your home automation all by oberon 7" elegant and friendly use touch screen.

Model: TIS-IP-INT-IN-7TS  
WIFI Standard / Rj45 terminal  
7'TFT-LCD 800x480 Pixel  
Capacitive touch screen  
Input Voltage: 12-24V/DC  
Dimensions : 276mm x 149mm x 20mm

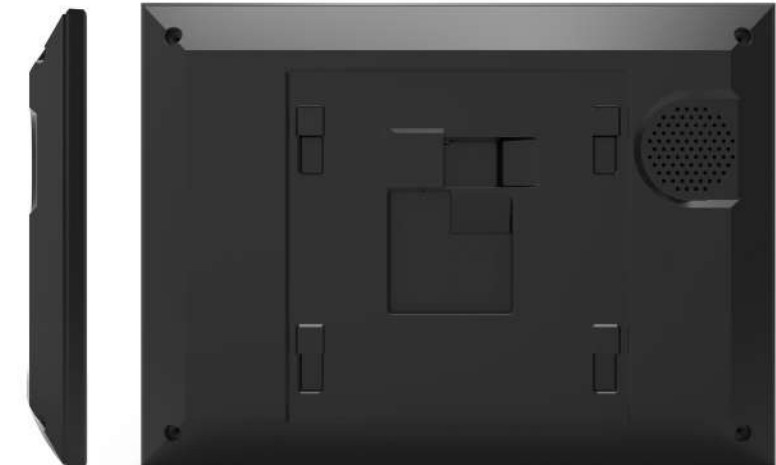





OBERON Building Intercom

Building Digital Outdoor Video Door Phone

Oberon digital coding building outdoor video door phone is an IP based door phone installed for buildings or towers with more than 10 units up to 1000 units , it can call Oberon indoor monitor in each unit. while the indoor unit will forward the call to smart phones application, so you can answer your door anywhere.

The outdoor unit came with a RF card reader for access control, digital camera and night vision,

Model : TIS-IP-INT-OUT-TWA  
 Input Voltage:12V/DC / 3A  
 Ethernet: Rj45 terminal  
 Dimensions : 405mmL x 145mmW x 58.5mmH



OBERON 4-12 units Intercom

Used to call small buildings with 4-12 units, it will call Oberon indoor monitor in each unit. The indoor unit will also forward the call to smart phones to answer your door anywhere. The outdoor unit came with RF card reader for access control, digital camera, night vision, and backlight label.

Model : TIS-IP-INT-OUT-12G  
 Input Voltage: 12V/DC / 3A  
 Ethernet: Rj45 terminal  
 Dimensions :  
 300mmLx127mmWx32mmH



OBERON Outdoor 1 Unit Door Phone

Used to call 1 unit, such as apartment or villa, can be installed outdoor or indoor, it will call Oberon indoor monitor in each unit. The indoor unit will also forward the call to smart phones to answer your door anywhere.

Model: TIS-IP-INT-OUT-VDP  
 Input Voltage: 12V/DC / 3A  
 Ethernet: Rj45 terminal  
 Dimensions :  
 165mmLx75mmWx31mmH

# WIFI DOOR BELL



With WiFi Doorbell, you are always at home.

See who's there, from anywhere it's like you're home even when you're not.

## Enhanced Technology

Working in both WIFI Local LAN and internet connection mode, You can add the TIS Chime as an extension of your WIFI Doorbell, letting you know you have a visitor even when your phone is off

## SECURITY

notifying you when someone is on your property, and letting you see and speak with anyone that will help to prevent a break-in from taking place at all

## MONITORING

No need to wonder if something is going on outside your home, see for yourself.

## CONVENIENCE

You shouldn't have to arrange your life around to wait your visitors

Model: TIS-VDB-SIP7

Input Voltage: 12V/DC / 3A

Ethernet: Rj45 terminal / WIFI 2.4 Ghz

Dimensions : 165mmLx75mmWx31mmH

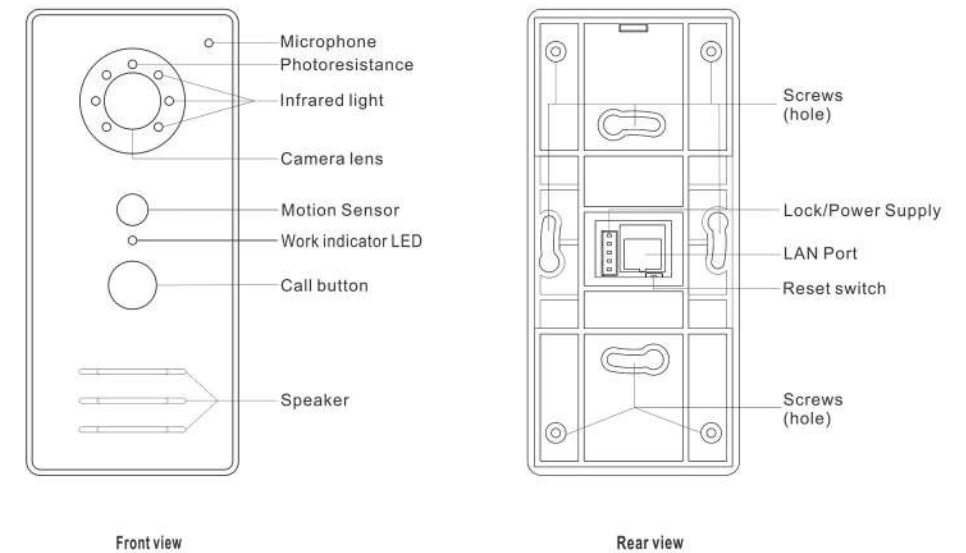



# 1001

## WiFi Indoor Robo Camera



Model: ROBO-CAM-1001



Designed to secure your home with SD card recording function, night vision, microphone and speaker, allowing you to see, hear and talk. You can use it as baby monitor and as communication device with your family. Also you can control and monitor it by TIS Application and receive message through APP when camera motion detection activated.





# AIR Controller

Power socket  
Relays  
Dimmers  
Infrared Emitter  
Motion sensor  
Digital Inputs  
Curtain Control  
AIR BUS Gateway

AS SIMPLE AS THAT



# AIR Power Socket

Plug your TIS-AIR Socket to any table light, fan, electric heater or other home appliance and control it simply from anywhere.

Available as on/off switch socket or dimming socket.

No need gateway or additional hardware between, TIS Socket is very simple to monitor control by your smart phone or by other panels and touch screens.



Air-Socket-S ON/OFF Socket  
Air-Socket-D Dimmer Socket

Model Number	Air-Socket-S	Air-Socket-D
Working voltage	AC85-230V 50/60Hz	AC85-230V 50/60Hz
Output channel	1 CH Relay	1 CH Dimmer
Output current	16A 250VAC	CH Load ≤ 1.5A
TIS AIR Module	Yes	Yes



UK

US

EU

## AIR Dimmer & Switch Module (ADS)

Install it Anywhere  
and Link it to WIFI

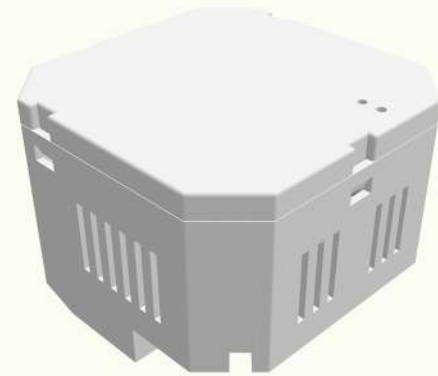

TIS ADS range provide relay and dimmer controllers that is basic in any automation system. It is suitable for everything from controlling and dimming LED to fluorescent lights, or changing the color of LEDs strip lights, Also can be used to control curtain motors , gate or other home appliances. With an expected service life greater than 25 years, can assure that your automation system will stand for long time.

Dimensions:49x49x36mm

## ADS Dimmer

Use both a live, and neutral connection to power on the ADS Module.  
Capable of MOSFET dimming and switching, where as it can dim most of load types.

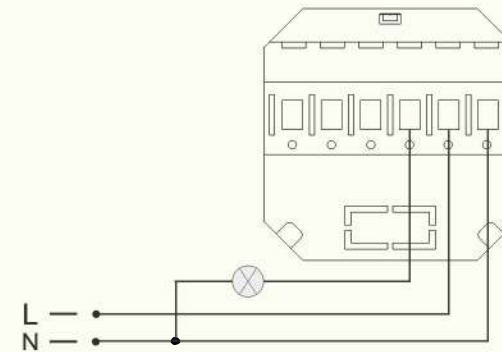

Working voltage:AC85-230V 50/60Hz  
Output:1channel  
Output current:Channel Load  $\leq$  1.5A

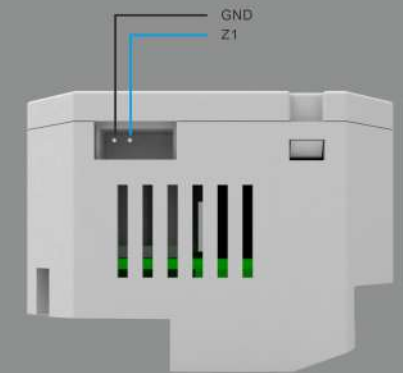
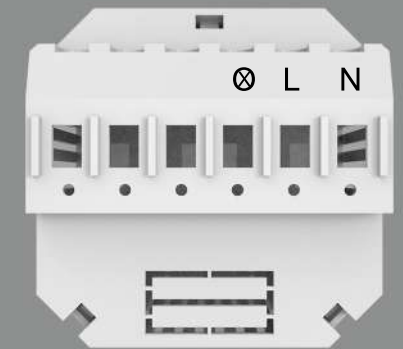

ADS-1D-1Z



# ADS LED RGBW

Used to control 0-10V LED Driver lights, the four channel dimmer can dim 4 channels of 0-10V driver connected to different LEDs or florescent lights, or it can control the color of a single red,green, blue, white color strip.

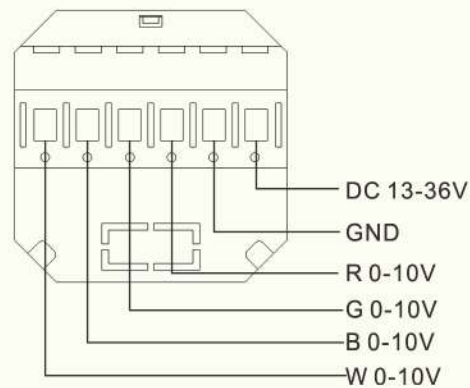

Input voltage : DC 13-32V  
0-10VDC output for each channel : 0-30mA

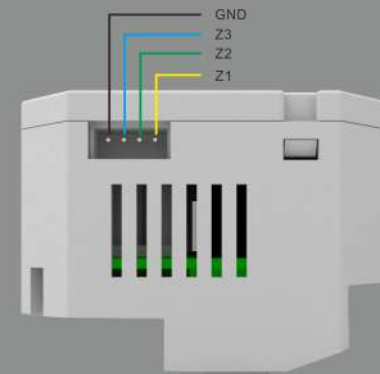
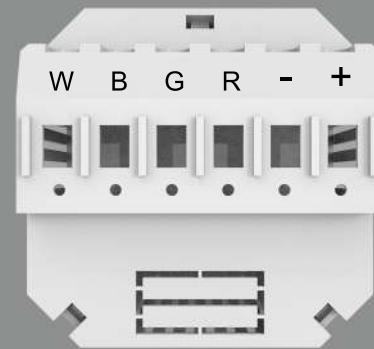

ADS-4CH-0-10V

# ADS RELAY

Used to control lights ON/OFF, closing and opening the curtain motors, and used for turning ON/OFF other appliances

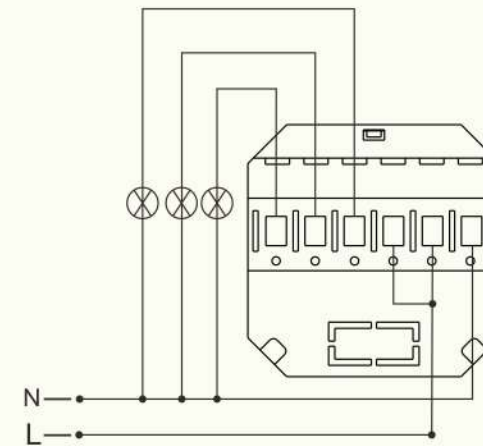

Model Number	ADS-3R-3Z	ADS-2R-2Z	ADS-3R-BUS
<b>Working voltage</b>	AC85-230V 50/60Hz	AC85-230V 50/60Hz	AC85-230V 50/60Hz
<b>Output channel</b>	3CH relay	2CH relay	3CH relay
<b>Input connection</b>	Line & Neutral connection	Line & Neutral connection	Line & Neutral connection
<b>Output current</b>	8A 250VAC per CH	8A 250VAC per CH	8A 250VAC per CH
<b>Digital dry inputs</b>	3	2	N/A
<b>TIS AIR Module</b>	Yes	Yes	N/A
<b>TIS BUS Port</b>	N/A	N/A	Yes

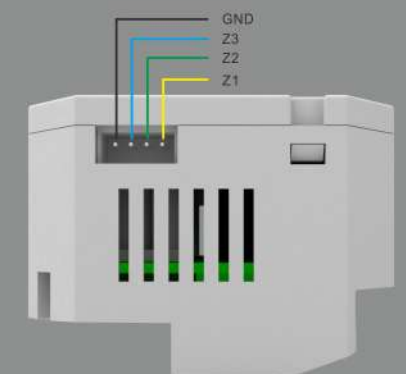
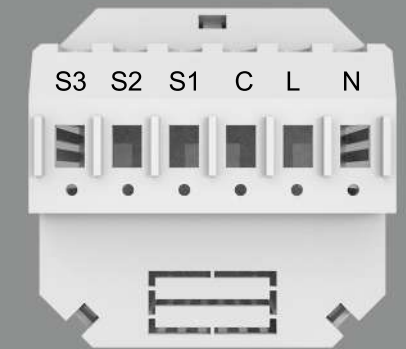

ADS-3R-3Z

# AIR Coupler Module

Air Couplers are small size modules, installed mainly behind the traditional switches to convert it into smart switches allowing any device in the TIS AIR to be controlled.

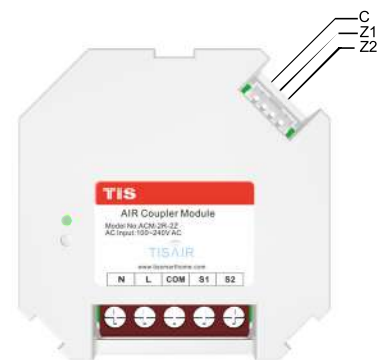
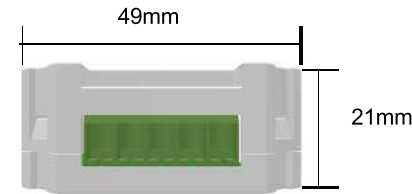

**ACM-2R-2Z**

Dimensions: 49x49x20mm

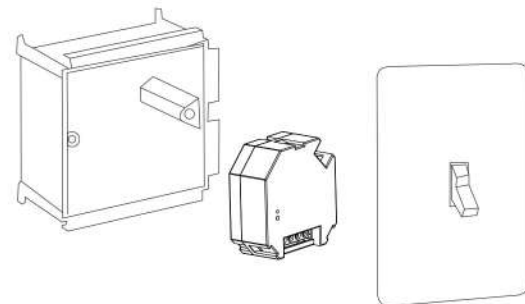

Model Number	ACM-2R-2Z	ACM-1R-1Z	ACM-1D-1Z
<b>Working voltage</b>	AC85-230V 50/60Hz	AC85-230V 50/60Hz	AC85-230V 50/60Hz
<b>Output channel</b>	2CH relay	1CH relay	1 Universal Dimmer
<b>Input connection</b>	Line & Neutral connection	Line & Neutral connection	Line & Neutral connection
<b>Output current</b>	5A 250VAC per CH	5A 250VAC per CH	1A per CH
<b>Digital dry inputs</b>	2	1	1
<b>TIS AIR Module</b>	Yes	Yes	Yes

# AIR Infrared Emitter

Control your split Air condition or television, and other appliances from a TIS wall panels or your mobile device. TIS Infrared emitter designed to control all infrared devices and appliances to bring you a centralized management solution for your home theater devices.

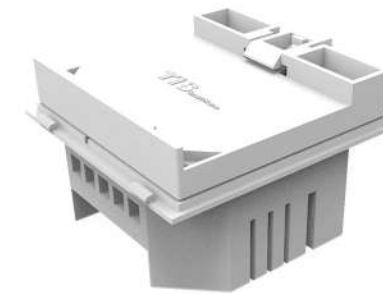

**AIR-1IRE-T** with one Infrared emitter port and one temperature sensor input. used mainly for Split AC to be controlled and monitored by your application, showing the room temperature and controlling your split anywhere.

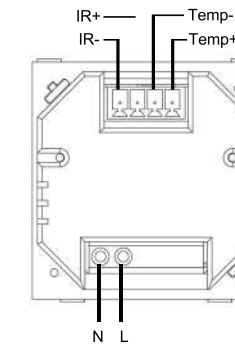
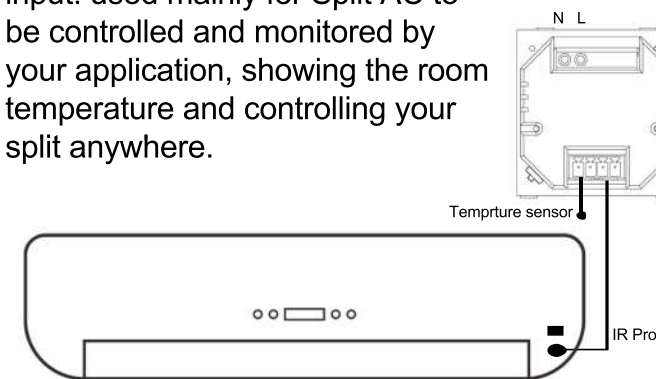

**AIR-1IRE-T**

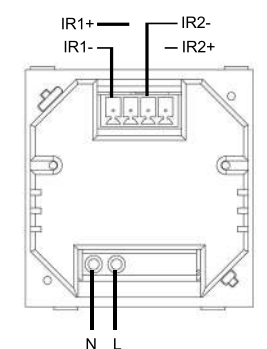

**Air-2IRE**

**Air-2IRE** with separated 2 Infrared ports used for home theater and to control 2 device with same brand separately with the ability of 2 ports of infrared sending by one device.

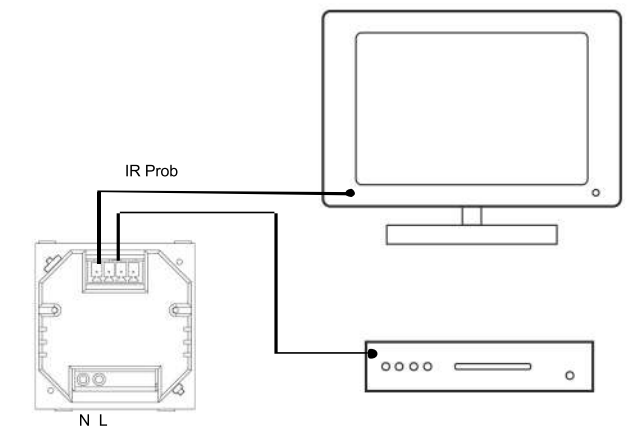

# TIS AIR BUS

Designed to bridge the gap between wired and wireless Bus installations, the mini converter enables fast and efficient upgrades to be completed almost instantly. with automatic address setting, all you need to do is connect the converter to your selected wired module, and configure it by using your Android or IOS device. Air Bus is a module designed to link between wired TIS-BUS and wireless TIS-AIR installation.

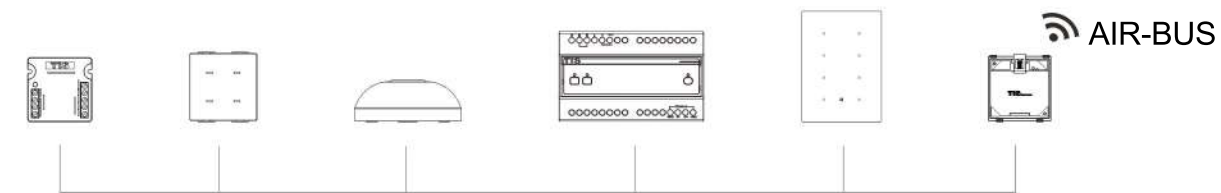
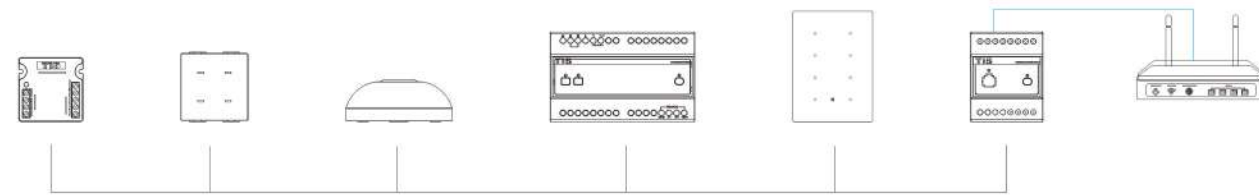
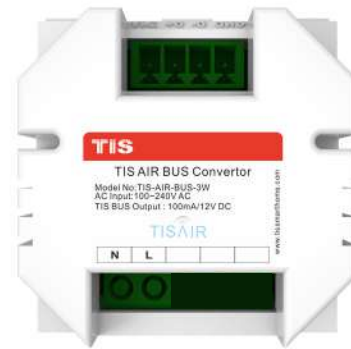

It can be installed as Din rail and link TIS-BUS devices to WIFI or it can be installed as panel Addition behind the Luna, Mars or Terre series to convert it to WIFI AIR Panels.

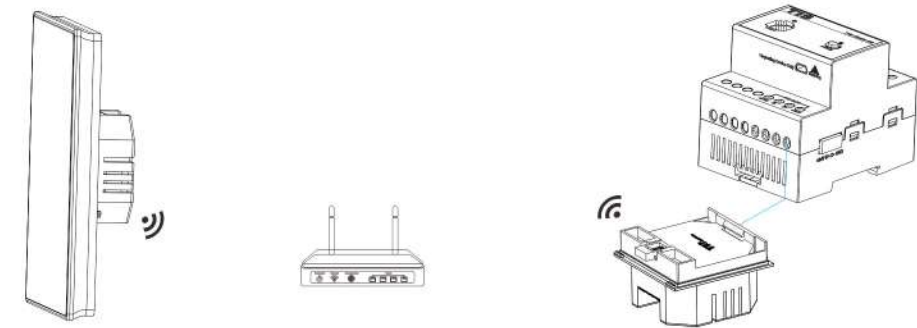

TIS AIR BUS come with or without Power supply:

TIS-AIR BUS-3W (with power supply) working with AC 85-230V

TIS-AIR-BUS (without power supply) working with Bus DC 24V ;

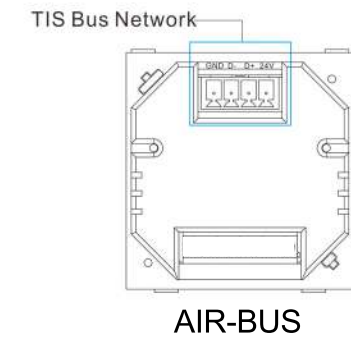
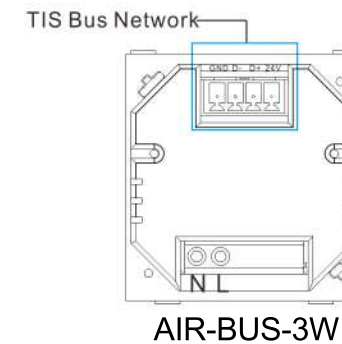

# Sensors

The AIR-ES-IR is a ceiling mount PIR motion detector with 180 degree infrared emitters, and one lighting relay switch channel, also it has 32 Logic lines available which allows is integration. Its logic capabilities, which allows maximum of saving energy by control climate and ensure efficient use of systems when required.



AIR Energy Servant Sensor

The AIR-PIR-CM is motion detector with one lighting relay switch, which is suitable for areas which only require motion detection for saving energy.



TIS AIR PIR Motion Sensor

## AIR 3 Channel Dry Contact Inputs

ACM-3Z-IN AIR three channel dry contact inputs is a WIFI module enables you to convert a traditional switch, into a smart switch capable of controlling any TIS Air device. Also it can be connected to other sensors from magnetic sensors used for door and window security, to N/C N/O PIR detectors, TIS Water Leakage and any dry contact signal linked to it.

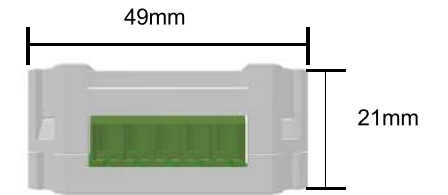

Dimensions: 49x49x20mm

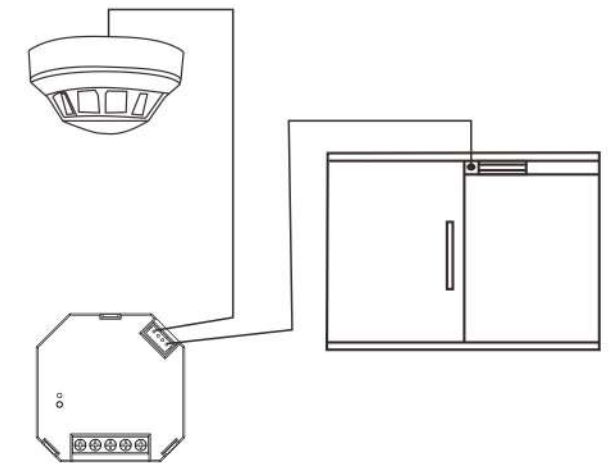
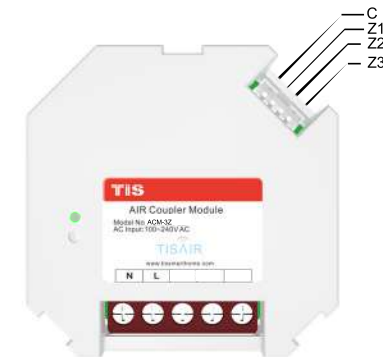



## Roller, Blinds and Shades Control

Motorise all types of interior window coverings by TIS motors, such as: roller or Roman/woven shades, horizontal blinds, sheer, and draperies.



TIS motors are also ideal for large windows, high-up or hard to reach window coverings.



Conveniently close or open all your blinds or shades at the same time, perfectly positioned and aligned to any percentage you choose with a touch of a button from your tablet, panel or remote. No more tangled up cables.

## Curtain control

Motorise your drapery track to get rid of pulling heavy or, hard to reach draperies. No more cables to operate or strings that get tangled up. Enhance your lifestyle by making your curtains so easy to use, by single touch of button you will experience benefits how simple to eliminate the harmful sun's rays inside room, or giving you instant privacy ...

Considering a curtain for your home? Motorise curtains add distinction to any living space.

You can use any fabric and design type of your choice and still experience the convenience and luxury of TIS automation



**TIS**

APPLICATIONS  
&  
SOFTWARES

I CAN  
CONTROL  
MY HOME  
FROM  
MY  
WATCH



## IOS application

TIS offer free application for your ipad iphone and I Watch to control all TIS products, making your home lighting, climate, security management simple under your control .



## Android Application

Our android app suits any android enabled device, a DIY simple application to control all your home lighting, climate, security, curtain and others.



Many other developers application also available with different interface and graphicals, you can contact us for more information about all our compatible applications .







## Where you can buy

USA  
TIS Americas

Australia  
TIS Technology

Brazil  
Fastquality distribuidora LTDA

China  
Automation Technology LLC

Greece  
HAT Security LTD

India  
South: SeQure Sustainable Solutions  
Gujarat:Swastik Home Automaition  
Delhi NCR: Mayfair Enterprises

Kuwait  
Intelligent Technologies

Maldives  
Morelinks Tech

Malta  
Energy Technologies Ltd.

Morocco  
MED Technologies

Pakistan  
Tera Generation Solutions Pvt Ltd

Panama  
Ecsa-La

Russia  
Diatonik Ltd

United Arab Emirates  
Smart Living Electronics Trading L.L.C

Vietnam  
TIS Viet Nam Smart Equipment Joint  
Stock Company

Authorized Dealer



For more information please contact us at [info@tissmarthome.com](mailto:info@tissmarthome.com)  
Our visit us at [www.tissmarthome.com](http://www.tissmarthome.com)